Safety

Dixon®'s couplings and retention devices are designed to work safely for their intended use. The selection of the proper hose, coupling and retention device, and the proper application of the coupling to the hose are of utmost importance.

Users must consider the size, temperature, application, media, pressure and hose and coupling manufacturer's recommendations when selecting the proper hose assembly components. Dixon recommends that all hose assemblies be tested in accordance with the Association for Rubber Products Manufacturer's (ARPM) recommendations and be inspected regularly (before each use) to ensure that they are not damaged or have become loose. Visit ARPMINC.com for more information.

Where safety devices are integral to the coupling, they must be working and utilized. The use of supplementary safety devices such as safety clips or safety cables are recommended.

If any problem is detected, couplings must be removed from service immediately.

Dixon is available to consult, train and recommend the proper selection and application of all fittings we sell. We strongly recommend that distributors and end users make use of Dixon's Testing and Recommendation Services. Call 877.963.4966 or click dixonvalve.com to learn more.



The Importance of Whip Hose

The constant vibration created by air tools, like air drills and pavement breakers, is destructive to air hose couplings, especially the quick-acting type. To provide a safer working environment, connect one end of a 3' to 10' length of air hose to the tool using Dixon's No. 3500 Steel Nipple. This nipple is designed to specifically handle vibration applications. Connect the other end of hose to the air supply using the standard quick-acting coupling. The Whip Hose should remain permanently connected to the tool.



OSHA Regulations

ASME Air Receiver Manifold-1910.169; 1926.306
King Safety Cable- 1926.302 (b1)
Air King® Safety Clip-1926.302 (b2)

Safety Check Valve- 1926.302 (b7)
Safety Vented Ball Valve- 1910.147

The regulations may be viewed in full on the OSHA website, osha.gov. Please check the website for updates.

Installation and Inspection Procedures

Procedure # 1000

Boss® clamp selection

Procedure # 2000

Installation of Boss 2 bolt clamp

Procedure # 2001

Installation of Boss 4 bolt clamp

Procedure # 2300

Installation of King Cable®

Procedure # 2306

Crimping Unirange, Air King, Dix-Lock® and Dual-Lock couplings

Procedure # 3001

Bolt Clamp Inspection

A printed copy of the complete Installation and Inspection Procedures Manual is available upon request.

All dimensions are nominal.

Detailed view of manifold assembly

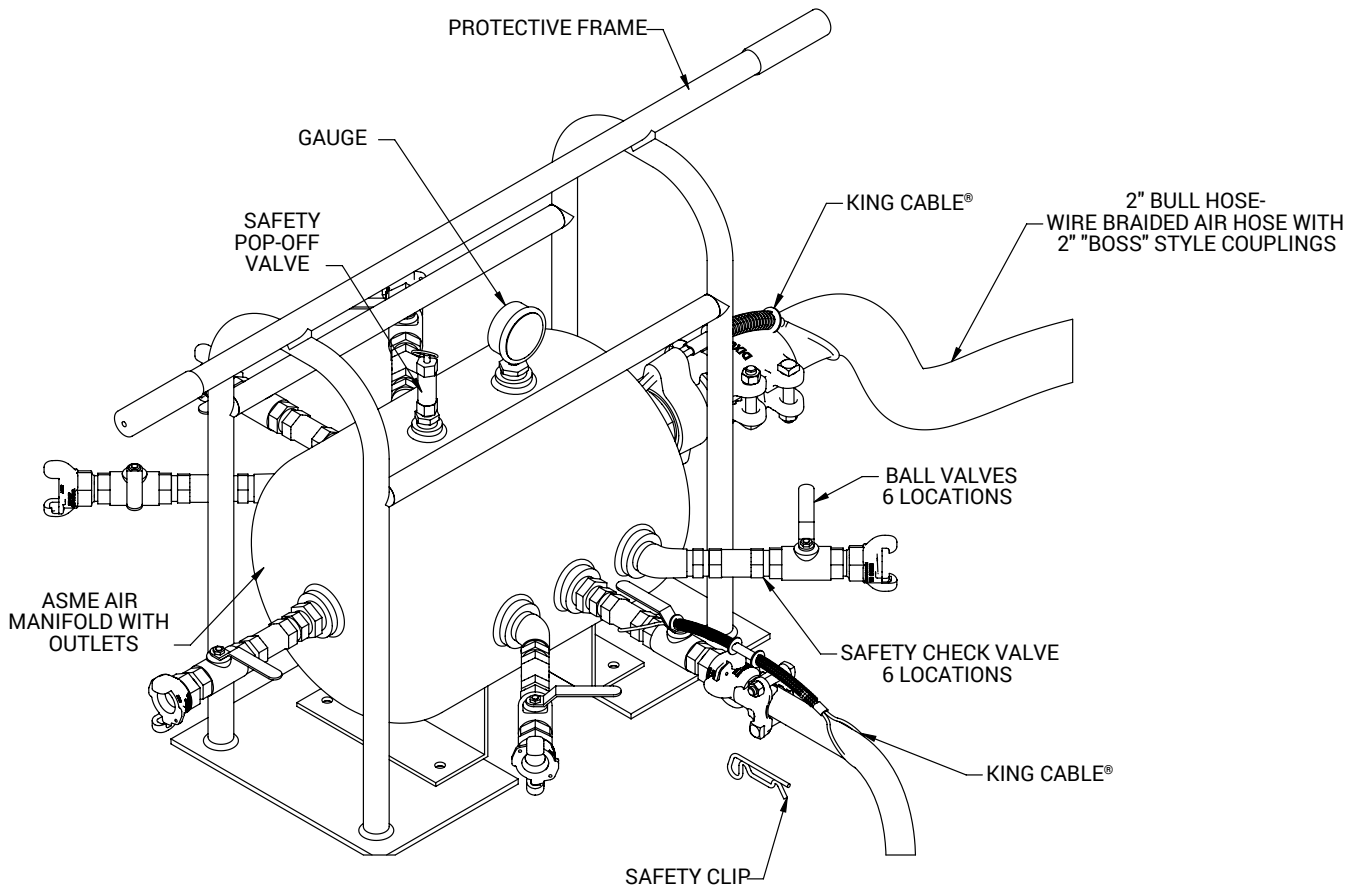

Compressor 125 CFM

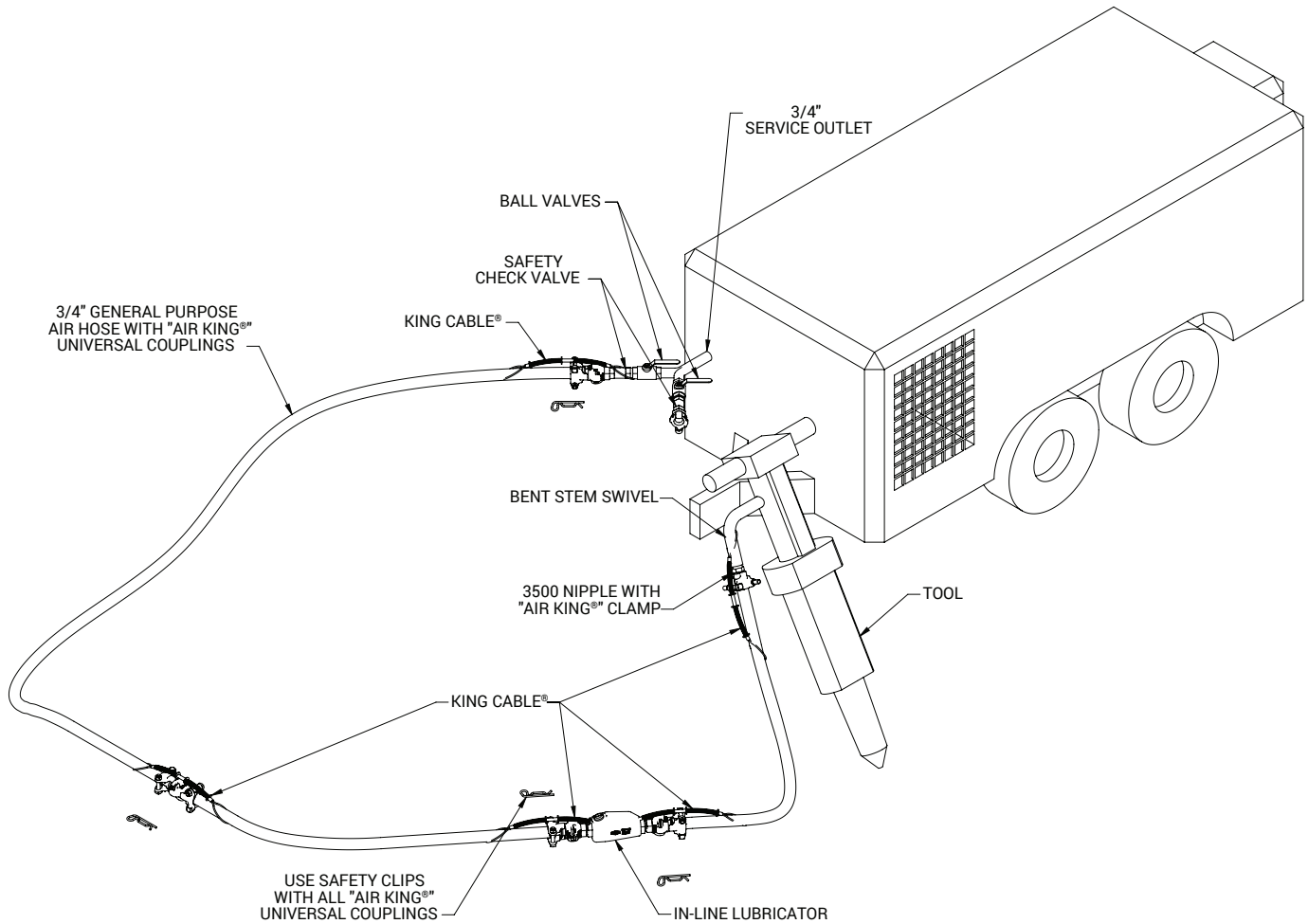

Compressor 600 CFM

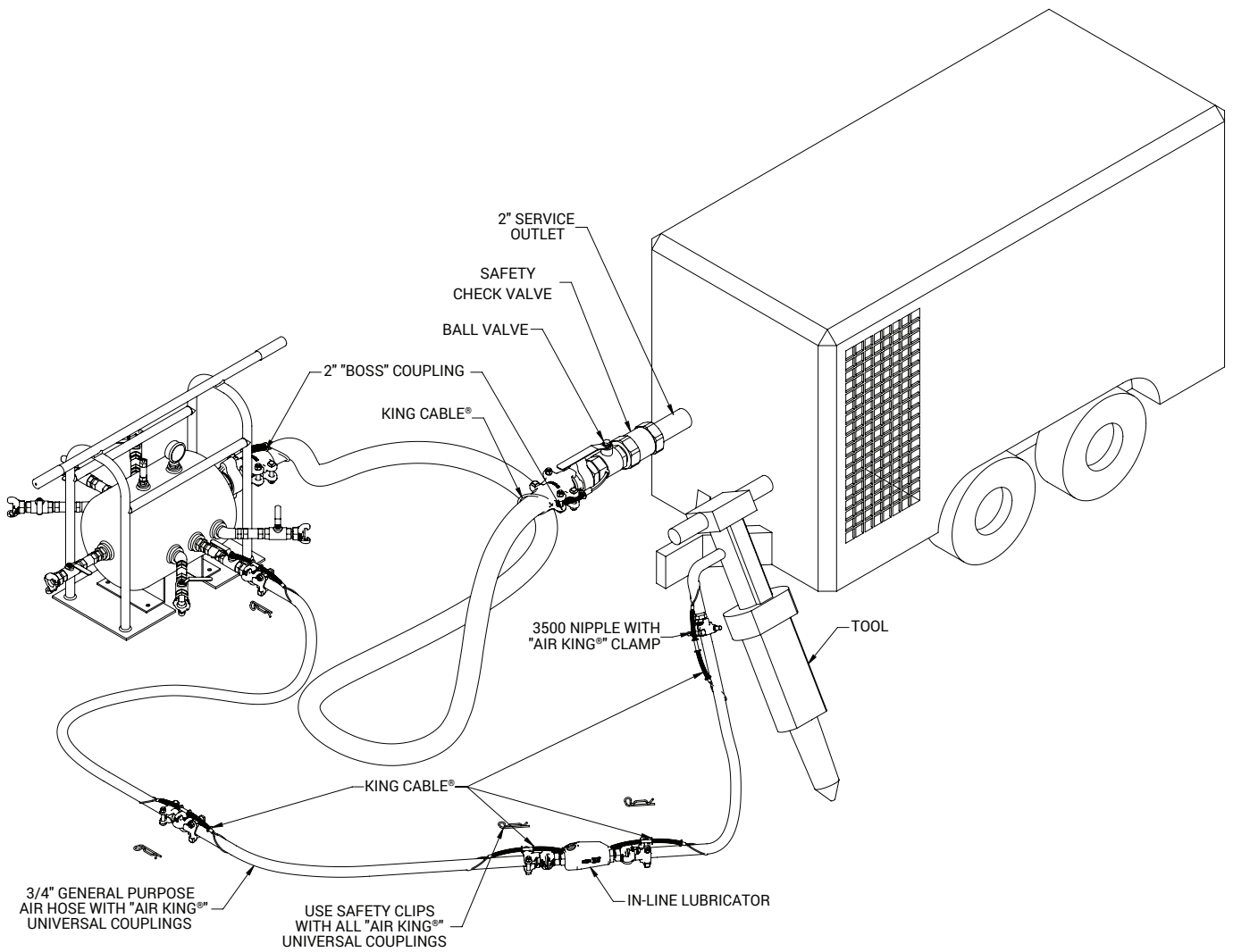

Air King® Universal Couplings

Service

- The maximum recommended working pressure for Air King is **150 PSI** at ambient temperature **70°F (21°C)**.
- For air and water service only. **Warning: Not to be used for steam.**



Features

- A universal head that is identical for all parts in the 1/4" to 1" range. With this head, any Dixon® fittings within that range can be connected regardless of hose shank or thread size.
- Couplings with optional ferrules permanently attached are provided ready to install.
- **Safety** - There are three safety features built into every Air King

1. Washer design (A) – Dixon AWR4 washers supplied with every Air King are designed to seal up to **150 PSI**. The washer design helps keep the coupling together while pressurized.
2. Internal lug design (B) –Cast inside each Air King lug is a ninety-degree step that locks with an opposite step on the outside of the adjoining Air King part. These step-locks provide additional holding power to keep the Air King connected up to its **150 PSI** rating at **70° F (21°C)** ambient temperature.
3. Safety clip (C) – Unexpected twisting of hose assemblies can occur during use. To eliminate the possibility of accidentally disconnecting, each Air King comes with a safety clip. This clip is designed to be inserted into the locking holes (D) on the fittings. The use of a safety clip assures the users that the fittings have been properly connected.

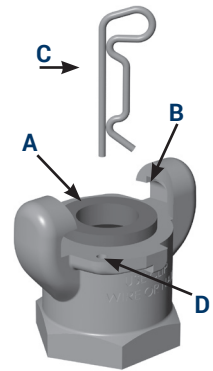

Connecting

- Push two couplings together and turn the one in your right hand until they seat.
- Insert an Air King safety clip through the hole in the flanged area of the head. If a safety clip is not available, use a cotter pin or wire type retainer. Lanyards (not pictured, see page 8) are available separately to fasten the Safety Clip to the locking head.

Disconnecting

- Remove the safety clip, cotter pin or wire. Press the couplings together and turn the one in your right hand until they unseat. **Never attempt to disconnect any hose while pressure is in the line.**



Interchange

- Although Air King may couple with other manufacturers' fittings, **we do not recommend their use with other products.** Not all universal locking heads are made to the same standard.

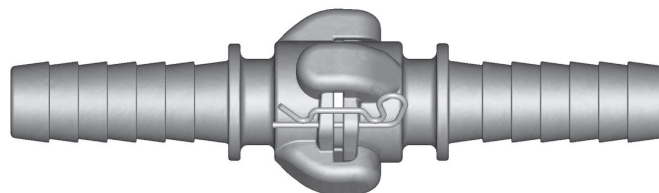

Air King meets pressure requirements as specified in Commercial Item Description A-A-59553 that supersedes Mil Spec. WWC-633D.

⚠ WARNING

The use of an Air King® safety clip or wire type retainer is necessary to ensure Air King universal couplings will not become accidentally disconnected. This guarantees the fittings are properly connected because the safety pin will not go through the holes in mating flanges until couplings are locked in place. Only one Air King safety clip or wire type retainer is required for each Air King universal coupling.

Features

- Can be used with Air King ferrules
- Supplied with safety clip
- Supplied with rubber washers, part # AWR4

Specifications

- Pressure rating: **150 PSI** at ambient temperature **70°F (21°C)**
- Meets pressure requirements as specified in A-A-59553 commercial item description superseding Mil Spec.WWC-633D

2-Lug Male NPT Ends

Feature

- Male NPT thread with hex for a wrench

Size	Iron Part #	Brass Part #	316 Stainless Steel Part #
1/4"	AMB1	ABB1	---
3/8"	AMB	ABB	RAMB
1/2"	AM2	GAB2 ¹	RAM2
3/4"	AM7	GAB7 ¹	RAM7
1"	AM12	GAB12 ¹	RAM12

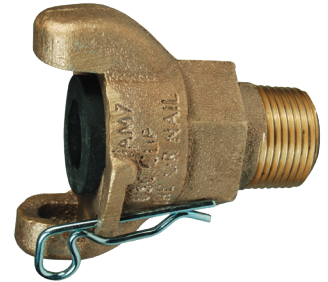

¹ Global investment cast

Dimensions

Size	A	B	C	D	E	NPT
1/4"	2-1/2"	2-9/16"	1"	9/16"	5/8"	1/4"
3/8"	2-1/2"	2-9/16"	1"	9/16"	5/8"	3/8"
1/2"	2-1/2"	2-11/16"	1-1/8"	1/2"	3/4"	1/2"
3/4"	2-1/2"	2-13/16"	1-3/8"	9-16"	13/16"	3/4"
1"	2-1/2"	2-13/16"	1-1/2"	3/8"	13/16"	1"

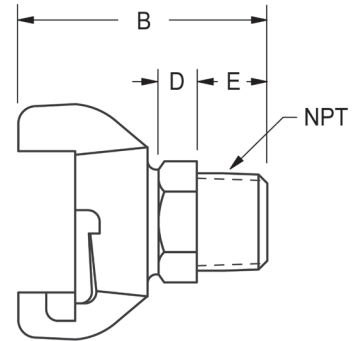
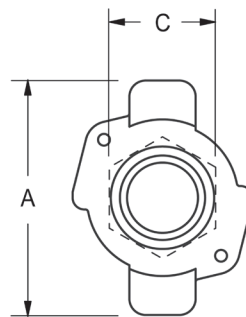

2-Lug Female NPT Ends

Feature

- Female NPT thread with hex for a wrench

Size	Iron Part #	Brass Part #	316 Stainless Steel Part #
1/4"	AMC1	ABC1	---
3/8"	AMC	ABC	RAMC
1/2"	AM3	GAB3 ¹	RAM3
3/4"	AM8	GAB8 ¹	RAM8
1"	AM13	GAB13 ¹	RAM13



¹ Global investment cast

Dimensions

Size	A	B	C	D	NPT
1/4"	2-1/2"	2-7/16"	1-1/8"	3/8"	1/4"
3/8"	2-1/2"	2-7/16"	1-1/8"	3/8"	3/8"
1/2"	2-1/2"	2-7/16"	1-1/8"	3/8"	1/2"
3/4"	2-1/2"	2-7/16"	1-7/16"	3/8"	3/4"
1"	2-1/2"	2-1/16"	1-5/8"	3/8"	1"

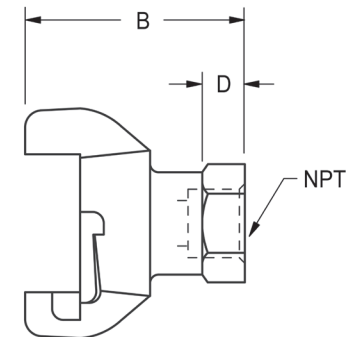
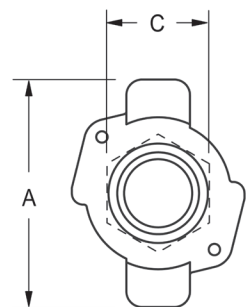

NOTE: Air King is for air and water service only, Warning: Never use any Air King coupling for steam service! None of Dixon®'s catalog information is to be interpreted to mean that this type of coupling is suitable for use on steam hose.

2-Lug Hose Ends

Features

- Can be used with Air King ferrules
- Supplied with safety clip
- Supplied with rubber washers, part # AWR4

Specifications

- Pressure rating: **150 PSI** at ambient temperature **70°F (21°C)**
- Meets pressure requirements as specified in A-A-59553 commercial item description superseding Mil Specification WWC-633D

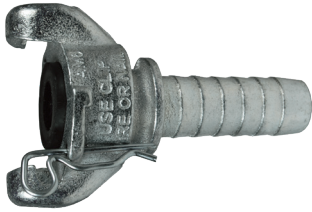

Size	Iron Part #	Brass Part #	316 Stainless Steel Part #
3/8"	AMH ¹	GABH ¹	RAMH
1/2"	AM1	GAB1 ¹	RAM1
5/8"	AM5	AB5	---
3/4"	AM6	GAB6 ¹	RAM6
1"	AM11	GAB11 ¹	RAM11

¹ Global investment cast

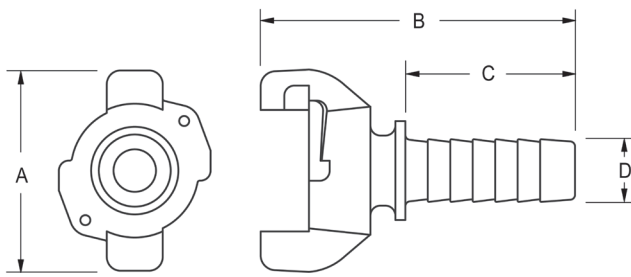

Dimensions

Size	A	B	C	D
3/8"	2-1/2"	3-7/16"	1-5/8"	7/16"
1/2"	2-1/2"	3-7/16"	1-5/8"	17/32"
5/8"	2-1/2"	4-1/4"	2-7/16"	11/16"
3/4"	2-1/2"	4"	2-1/16"	25/32"
1"	2-1/2"	4-25/32"	2-11/16"	1-1/16"

Clamps

Feature

- Torque values for clamps are based on dry bolts, the use of lubricant on bolts will adversely effect clamp performance



Size	Hose O.D.		Zinc Plated Iron Part #	Torque ¹
	From:	To:		
3/8"	44/64"	56/64"	CD ³	6
1/2"	1"	1-12/64"	A4 ³	6
3/4"	1-8/64"	1-20/64"	A9 ³	21
1"	1-20/64"	1-32/64"	A10 ^{2,3}	21
1"	1-32/64"	1-52/64"	A14	21

¹ Recommended torque rating in lbs.

² Can be used with AM6 and AM11

³ Global investment cast carbon steel

NOTE: Torque values for clamps are based on dry bolts, the use of lubricant on bolts will adversely effect clamp performance

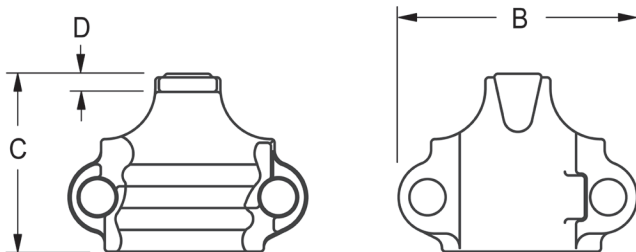

Dimensions

Size	A	B	C	D
3/8"	17/32"	1-11/16"	1-7/16"	1/8"
1/2"	25/32"	2-1/16"	1-17/32"	5/32"
3/4"	7/8"	2-13/16"	1-21/32"	1/8"
1"	1"	2-19/32"	1-15/16"	9/32"
1"	3/4"	3-1/32"	2-1/4"	5/32"

Blank Ends

Features

- Blank end fittings have no outlet and are used to block the line at any coupling point
- The end opposite the coupling head is flat, with an eye for a chain to secure the fitting when not in use

Iron Part #	Brass Part #	316 Stainless Steel Part #
AM0	GAB0 ¹	RAM0

¹ Global investment cast

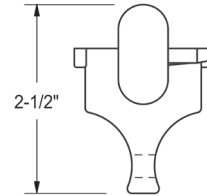
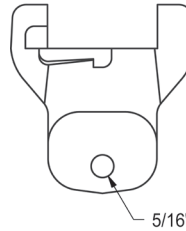
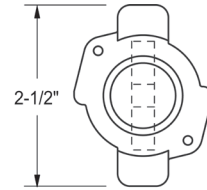

Triple Connections

Feature

- Triple connection consists of three universal couplings that provide an extra outlet when connected to the line

Iron Part #	Brass Part #
AM10	GAB10 ¹

¹ Global investment cast

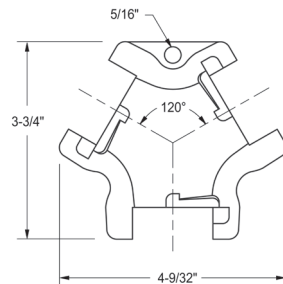

Air King® Safety Pins, Clips, Lanyards, and Washers

The use of an Air King safety clip or wire type retainer is necessary to ensure the couplings will not become accidentally disconnected. The clip will not go through the locking holes unless the couplings are locked in place. Only one safety clip or wire type retainer is required for each coupling.



Standard Safety Clips

Feature

- Same size for all coupling sizes

Wire Diameter	Part #
.080	AC1



Air King Safety Pins

Feature

- Heavy duty, oversized

Wire Diameter	Part #
.058	AKSP1
.091	AKSP25



Lanyards

Feature

- Same size for all coupling sizes
- Synthetic cord

Part #
ACL8



Stainless Steel Clips

Feature

- Same size for all coupling sizes

Wire Diameter	Part #
.072	AC7



Feature

- Breaking strength: 160 lbs.
- Overall length: 7" eye to eye

304 Stainless Part #
LR7



Washers

Features

- 2-lug couplings use the same size washer, part #'s AWR4, AWS6
- Neoprene is oil resistant
- 4-lug couplings use the same size washer, part #'s AWR14

Specifications

- Rubber temperature range: -20°F to 160°F (-29°C to 71°C)
- Neoprene temperature range: -20°F to 190°F (-29°C to 88°C)

Part #	Material	Style
AWR4 ¹	rubber	2 lug
AWS6	neoprene	2 lug
AWR14	rubber	4 lug

¹ Made from Styrene-butadiene (SBR)



Air King® with Ferrules



Features

- Design provides quick, easy, and effective coupling of air hose
- Interlocking ferrule can be crimped or swaged to achieve maximum coupling sealing and retention with a low-profile streamline appearance, for crimp or swage diameter recommendations go to dixonvalve.com
- For air and water service only 

Specification

- Working pressure: **150 PSI** at ambient temperature **70°F (21°C)**

Size	Hose O.D.		Iron Part #	316 Stainless Steel Part #
	From	To		
1/2"	54/64"	1-2/64"	AM1WF	RAM1WF
3/4"	1-4/64"	1-22/64"	AM6WF	RAM6WF
1"	1-18/64"	1-34/64"	AM11WF-1	---
1"	1-30/64"	1-46/64"	AM11WF	---
1"	2-1/64"	2-8/64"	AM21WF	---
2"	2-28/64"	2-40/64"	AM26WF	---

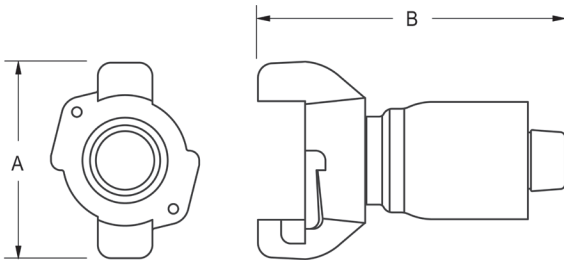

Dimensions

Size	A	B
1/2"	2-1/2"	3-7/16"
3/4"	2-1/2"	3-15/16"
1"	2-1/2"	4-25/32"
2"	3-3/4"	6-1/16"

4-Lug Quick Acting Couplings

Hose Ends



Features

- Not to be used for steam service, must use safety clips 
- Safety clips are same size for both 2-lug and 4-lug Universal Couplings, see page 9, use safety clips on all Universal Coupling applications
- Boss® clamps recommended, see pages 26 and 27 for clamp selection
- Supplied with safety clip and rubber washers

Specifications

- Pressure rating: **150 PSI** at ambient temperature **70°F (21°C)**

Size	Iron Part #
1-1/4"	AM16
1-1/2"	AM21
2"	AM26

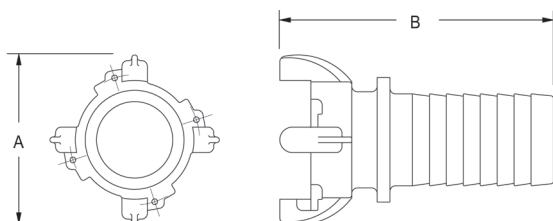

Dimensions

Size	A	B
1-1/4"	5-5/8"	3-3/4"
1-1/2"	5-7/8"	3-3/4"
2"	6-1/16"	3-3/4"

4-Lug Quick Acting Couplings

Female NPT Ends

Size	Iron Part #
1-1/4"	AM18
1-1/2"	AM23
2"	AM28



Dimensions

Size	A	B
1-1/4"	2-15/16"	3-3/4"
1-1/2"	3"	3-3/4"
2"	3-3/32"	3-3/4"

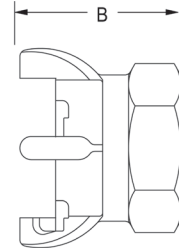
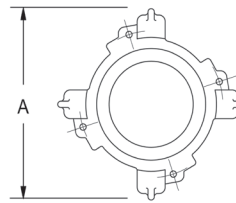

Rubber Washer for 4-lug

Part #
AWR14



NOTE: Fits all sizes

Male NPT Ends



Features

- Male NPT thread with hex for a wrench
- Supplied with safety clip and rubber washers

Size	Plated Steel Part #
1/2"	GAM2
3/4"	GAM7
1"	GAM12

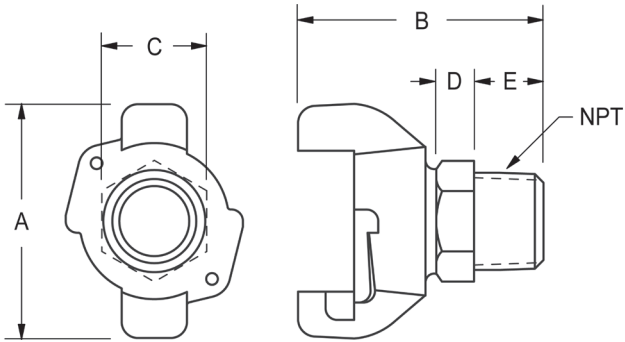

Dimensions

Size	A	B	C	D	E	NPT
1/2"	2-1/2"	2-11/16"	1"	3/8"	7/8"	1/2"
3/4"	2-1/2"	2-11/16"	1-11/32"	21/64"	7/8"	3/4"
1"	2-1/2"	2-3/4"	1-1/2"	5/16"	1"	1"

Female NPT Ends



Features

- Female NPT thread with hex for a wrench
- Supplied with safety clip and rubber washers

Size	Plated Steel Part #
1/2"	GAM3
3/4"	GAM8
1"	GAM13

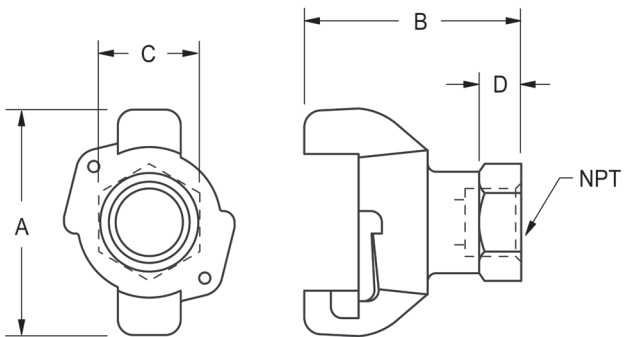

Dimensions

Size	A	B	C	D	NPT
1/2"	2-1/2"	2-1/8"	1-1/8"	3/8"	1/2"
3/4"	2-1/2"	2-5/32"	1-7/16"	3/8"	3/4"
1"	2-1/2"	2-13/16"	1-5/8"	3/8"	1"

Hose Ends

Feature

- Supplied with safety clip and rubber washers

Size	Plated Steel Part #
1/2"	GAM1
3/4"	GAM6
1"	GAM11

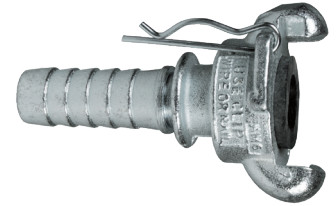

Dimensions

Size	A	B	C	D
1/2"	2-1/2"	3-3/8"	1-21/32"	17/32"
3/4"	2-1/2"	3-31/32"	2-1/8"	25/32"
1"	2-1/2"	4-21/32"	2-25/32"	1-1/16"

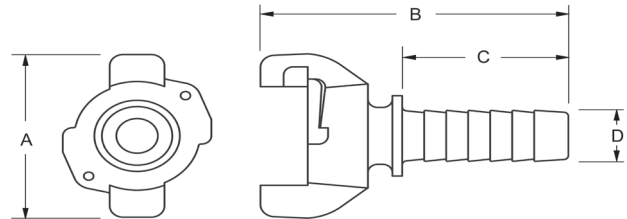

Blank Ends

Features

- Blank end fittings have no outlet and are used to block the line at any coupling point
- The end opposite the coupling head is flat, with an eye for a chain to secure the fitting when not in use

Plated Steel Part #
GAM0

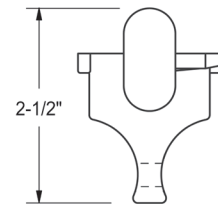
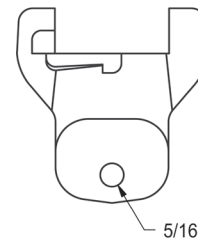
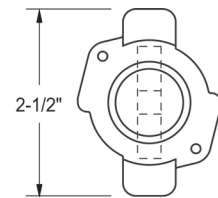

Triple Connection

Feature

- Triple connection consists of three universal couplings that provide an extra outlet when connected to the lineyeah

Plated Steel Part #
GAM10

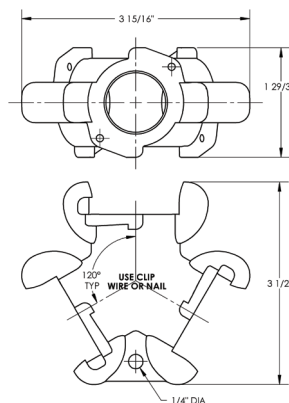

4-Lug Quick Acting Couplings - Hose Ends

Features

- Supplied with safety clip and rubber washers
- Use with Boss® clamps
- Not to be used for steam service
- Must use safety clips, safety clips are same size for both 2-lug and 4-lug Air King® Couplings

Specification

- Pressure rating: 150 PSI at ambient temperature 70°F (21°C)

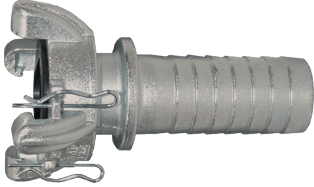

Size	Plated Steel Part #
1-1/4"	GAM16
1-1/2"	GAM21
2"	GAM26

Dimensions

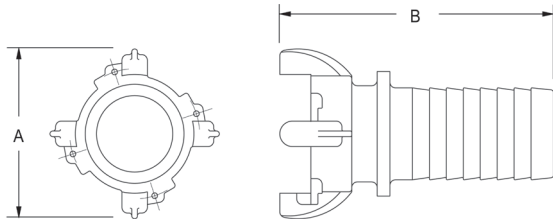

Size	A	B
1-1/4"	3-3/4"	5-5/8"
1-1/2"	3-3/4"	5-7/8"
2"	3-3/4"	6-1/16"

4-Lug Quick Acting Couplings - Female NPT Ends

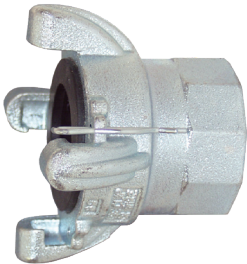

Size	Plated Steel Part #
1-1/4"	GAM18
1-1/2"	GAM23
2"	GAM28

Dimensions

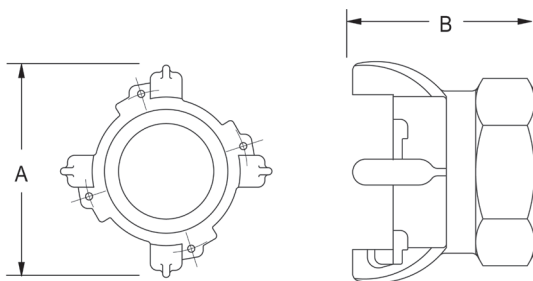

Size	A	B
1-1/4"	3-3/4"	2-15/16"
1-1/2"	3-3/4"	3"
2"	3-3/4"	3-3/32"

Boss Coupling System

Features

- The spud part of the coupling serves as one half of the connection and is usually fixed to the equipment. The stem part that is clamped to the hose is the other half. The two halves are connected or disconnected by rotating the wing nut onto the spud. When connected they achieve both a mechanical and a pressure seal.

Services

- Boss couplings are all-purpose hose couplings, universally recommended for steam hose connections. They are also widely used for air, water, fluid petroleum, chemicals, and liquid petroleum gas up to 1" I.D. Boss couplings can be applied to many types of rubber, synthetic, plastic, metallic, or semi-metallic hose. Consult Dixon® for specific media capabilities.

Purpose

Boss couplings supply a convenient threaded fitting to connect two lengths of hose, or a single length to a male or female threaded (NPT) outlet.

Materials

- Stem: 1/4" - 1" plated steel, 1-1/4" - 4" plated iron, 6" tubular steel
- Spud: 1/4" - 1" plated steel, 1-1/4" - 6" plated iron
- Wing nut: 1/4" plated steel, 3/8" - 6" plated iron

Seal Types

- Ground joint: copper or polymer seats
- Washer: Klingersil® C-4401

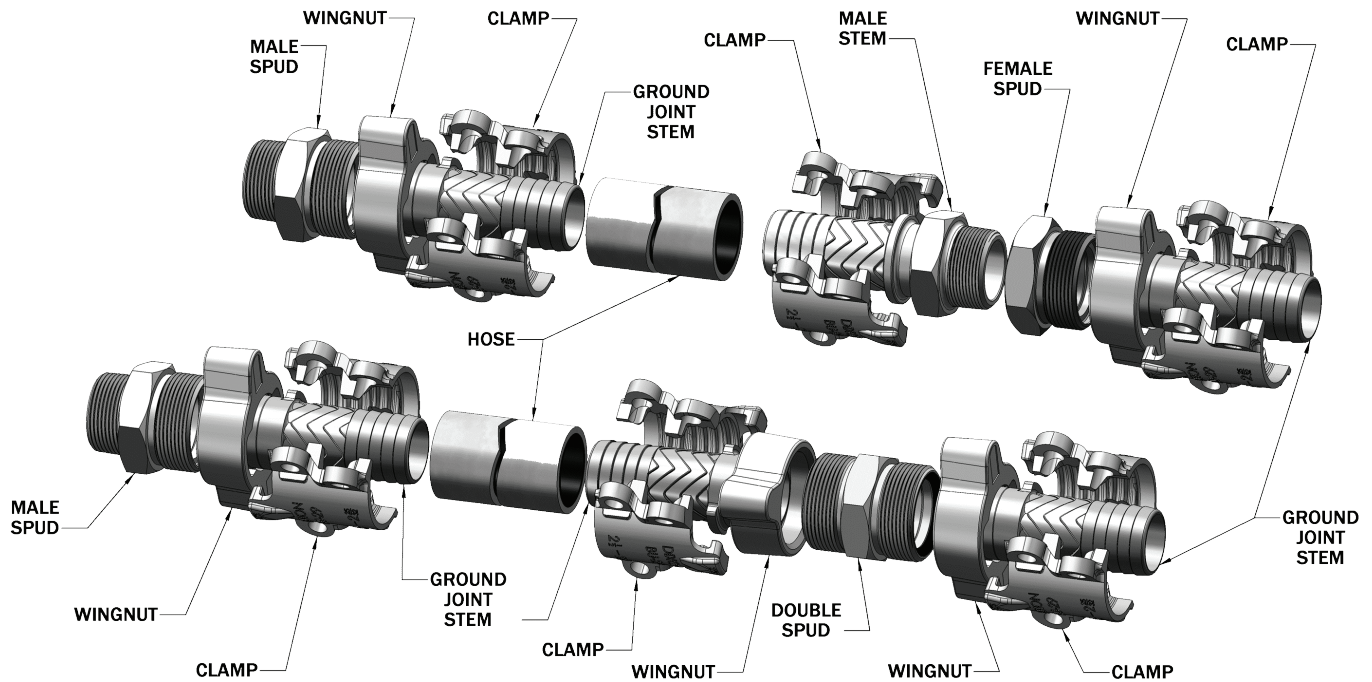

Worn-out hose couplings can be dangerous. They should be checked regularly and replaced when necessary. Each coupling user should review applications and add safety devices where indicated.



Boss Ground Joint Couplings with Female Spud

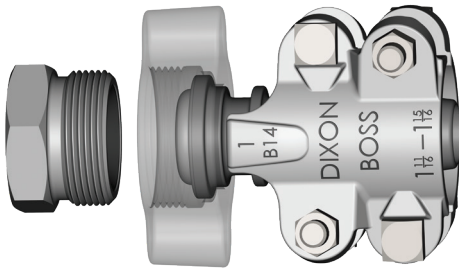

Features

- Positive metal-to-polymer seal
- Leakproof seal forms when the metal head of the stem makes contact with the patented polymer seat in the spud
- Non-metallic polymer seat resists most chemicals found in manufacturing facilities
- Easy to seal
- Use with Boss clamps found on page 26 and 27

Specification

- Recommended for steam service up to 450°F (232°C)



Hose Shank x NPT	Plated Steel and/or Iron Part #	316 Stainless Steel Part #	Brass Part #
1/4"	GF1 ¹	---	---
3/8"	GF3 ¹	---	---
1/2"	GF6	---	---
1/2" x 3/4"	GF26-1	---	---
3/4"	GF26	RGF26	BGF26
1"	GF36	RGF36	BGF36
1-1/4"	GF51	RGF51	---
1-1/2"	GF61	RGF61	---
2"	GF81 ²	RGF81 ²	---
2-1/2"	GF96	---	---
3"	GF111	---	---
4"	GF141	---	---
6"	GF201 ¹	---	---

¹ 1/4", 3/8", and 6" available only with copper seat spuds

² Not to be used with #250, #275, or #306 Boss clamps



Dimensions

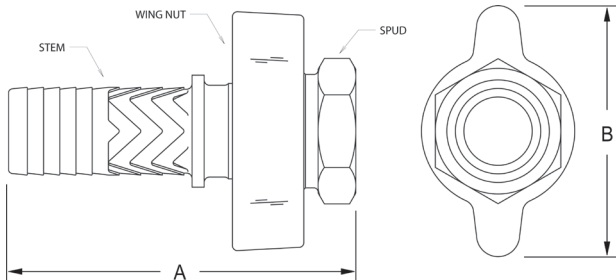

Size	A	B
1/4"	2-1/2"	1-5/32" ¹
3/8"	3-1/32"	1-3/4"
1/2"	3-21/32"	2-3/8"
3/4"	4-15/16"	3-9/16"
1"	5-3/16"	3-9/16"
1-1/4"	7"	4-1/4"
1-1/2"	7-1/4"	4-1/4"
2"	7-5/8"	5-5/8"
2-1/2"	9-5/32"	6-3/4"
3"	9-11/32"	7-3/4"
4"	11-1/2"	9-1/2" ²
6"	12"	12-1/4" ²

Note: 'A' dimension represents a complete coupling length with a female spud 'B' dimension is the largest dimension over the wing nut

¹ 1/4" coupling has a hex style nut

² 4" and 6" couplings have a 3 wing nut design

Boss Ground Joint Stems

Hose Shank x NPT	Plated Steel and/or Iron Part #	Optional Qty	316 Stainless Steel Part #	Brass Part #
1/4"	GBA	100	---	---
3/8"	GCA	100	---	---
1/2"	GB1	100	---	---
1/2" x 3/4"	GB6-1	50	---	---
3/4"	GB6	50	RGB6	BGB6
1"	GB11	50	RGB11	BGB11
1-1/4"	GB16	25	RGB16	---
1-1/2"	GB21	25	RGB21	---
2"	GB26 ²	10	RGB26 ¹	---
2-1/2"	GB31	5	---	---
3"	GB36 ²	5	---	---
4"	GB46	5	---	---
6"	GB66	2	---	---



Plated iron/steel



316 stainless steel



Brass

¹ Not to be used with #250, #275, or #306 Boss clamps

² GB26/GB36 have machined shank to accept Boss clamps, King Crimp® sleeves, ferrules. Use only Boss clamps on GB26/GB36 for steam service.

Only use the crimp style shanks with the crimp style sleeves and ferrules.

Due to differences in dimensions and tolerances for safety reasons, do not interchange other manufacturers' products with Dixon® products. Pressure rating is based on the seal of the mating part. Reference dixonvalve.com for a complete list of ratings.

The King Crimp sleeve and ferrule are not intended for steam service.



Boss Wing Nuts

Size	Plated Steel and/or Iron Part #	Optional Qty	316 Stainless Steel Part #	Brass Part #
1/4"	SLS4	100	---	---
3/8"	CB	100	---	---
1/2"	B2	100	---	---
3/4"	B12	25	RB12	BB12
1"	B12	25	RB12	BB12
1-1/4"	B17	25	RB17	---
1-1/2"	B17	25	RB17	---
2"	B27	10	RB27	---
2-1/2"	B32	5	---	---
3"	B37	5	---	---
4"	B47	5	---	---
6"	B67	2	---	---



Plated iron/steel



316 stainless steel



Brass

Boss Knurled Nut

Size	Plated Steel Part #	Optional Qty
3/4" and 1"	KB12	25



Boss Ground Joint Female Spuds

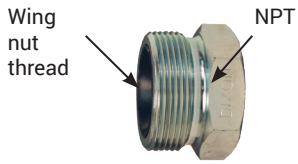

Size	Plated Steel and/or Iron Part #	Optional Qty	316 Stainless Steel Part #	Brass Part #
1/4"	GBC ¹	100	---	---
3/8"	GCC ¹	100	---	---
1/2"	GB3	100	---	---
3/4"	GB8	50	RGB8	BGB8
1"	GB13	50	RGB13	BGB13
1-1/4"	GB18	25	RGB18	---
1-1/2"	GB23	25	RGB23	---
2"	GB28	10	RGB28	---
2-1/2"	GB33	5	---	---
3"	GB38	5	---	---
4"	GB48	5	---	---
6"	GB68 ¹	2	---	---

¹ 1/4", 3/8", and 6" available only with copper seat spuds; all other sizes have polymer seats

Boss Ground Joint Male Spuds

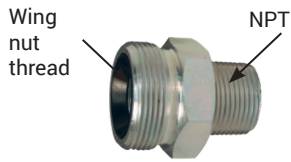

Size	Plated Steel Part #	Plated Iron Part #
3/8"	GMC ¹	---
1/2"	GM3	---
3/4"	GM8	---
1"	GM13	---
1-1/4"	---	GM18
1-1/2"	---	GM23
2"	---	GM28
2-1/2"	---	GM33
3"	---	GM38

¹ 1/4", 3/8", and 6" available only with copper seat spuds, all other sizes have polymer seats

Boss Ground Joint Double Spuds

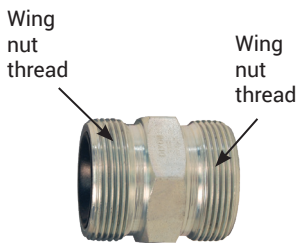

Size	Plated Steel Part #	Plated Iron Part #
1/2"	GDB3	---
3/4" and 1"	GDB13	---
1-1/4" and 1-1/2"	---	GDB23
2"	---	GDB28
2-1/2"	---	GDB33
3"	---	GDB38

Washer Type

Features

- Easy to seal
- Klingersil® C-4401 washer is inserted between the stem and spud
- Leakproof seal forms by rotating the wing nut and hammering it tight
- Use with Boss clamps found on pages 26 and 27
- Use with wing nuts found on page 16

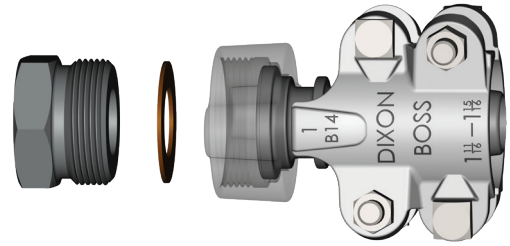

Specification

- Recommended for steam service up to 450°F (232°C)

Boss Washer Seal Couplings with Female Spud

Hose Shank x NPT	Plated Steel and/or Iron Part #	316 Stainless Steel Part #
3/8"	WF3	---
1/2"	WF6	---
1/2" x 3/4"	WF26-1	---
3/4"	WF26	RWF26
1"	WF36	RWF36
1-1/4"	WF51	RWF51
1-1/2"	WF61	RWF61
2"	WF81 ¹	RWF81 ¹
2-1/2"	WF96	---
3"	WF111	---

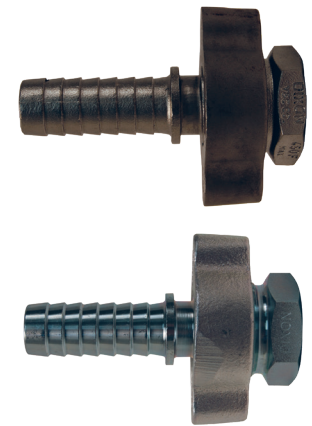

¹ Not to be used with #250, #275, or #306 Boss clamps



Dimensions

Size	A	B
3/8"	2-25/32"	1-3/4"
1/2"	3-7/16"	2-3/8"
3/4"	4-25/32"	3-9/16"
1"	4-31/32"	3-9/16"
1-1/4"	6-21/32"	4-1/4"
1-1/2"	6-7/8"	4-1/4"
2"	7-15/32"	5-5/8"
2-1/2"	8-25/32"	6-3/4"
3"	9-7/16"	7-3/4"

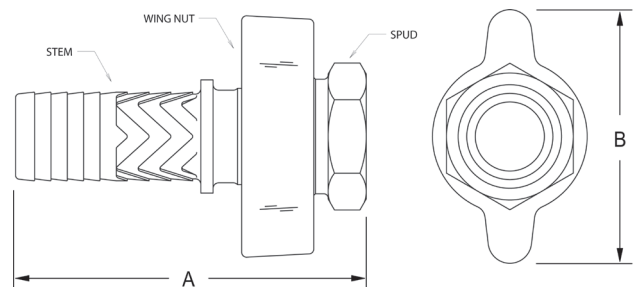

NOTE: 'A' dimension represents a complete coupling length with a female spud
 'B' dimension is the largest dimension over the wing nut

Boss Washer Seal Stems

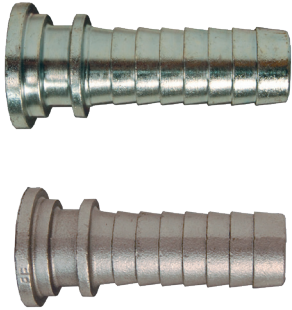

Hose Shank x NPT	Plated Steel and/or Iron Part #	Opt Qty	316 Stainless Steel Part #
3/8"	SS337	100	---
1/2"	B1	100	---
1/2" x 3/4"	B6-1	50	---
3/4"	B6	50	RB6
1"	B11	50	RB11
1-1/4"	B16	25	RB16
1-1/2"	B21	25	RB21
2"	B26 ¹	10	RB26 ¹
2-1/2"	B31	5	---
3"	B36	5	---

¹ Not to be used with #250, #275, or #306 Boss clamps



Boss Washer Seal Female Spuds



Thread Size	Plated Steel and/or Iron Part #	Opt Qty	316 Stainless Steel Part #
3/8"	CC	100	---
1/2"	B3	100	---
3/4"	B8	25	RB8
1"	B13	50	RB13
1-1/4"	B18	25	RB18
1-1/2"	B23	25	RB23
2"	B28	10	RB28
2-1/2"	B33	5	---
3"	B38	5	---

Boss Washer Seal Male Spuds

Thread	Plated Steel Part #	Plated Iron Part #
3/8"	WMC	---
1/2"	WM3	---
3/4"	WM8	---
1"	WM13	---
1-1/4"	---	WM18
1-1/2"	---	WM23
2"	---	WM28
3"	---	WM38

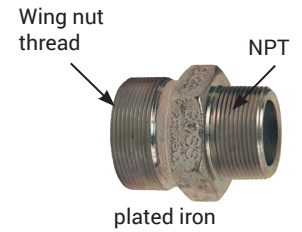

Boss Washer Seal Double Spuds

Thread	Plated Steel Part #	Plated Iron Part #
3/8"	---	---
1/2"	DB3	---
3/4"	DB13	---
1"	DB13	---
1-1/4"	---	DB23
1-1/2"	---	DB23
2"	---	DB28
3"	---	DB38

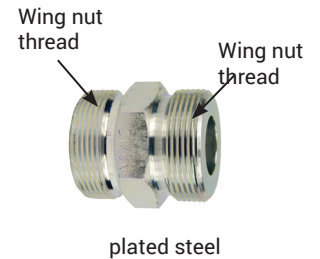

Boss Washer Seal Washers

Size	Nitrile Rubber Bonded, Non-Asbestos Klingersil® C-4401 Part #
3/8"	WBC
1/2"	W2
3/4"	W12
1"	W12
1-1/4"	W17
1-1/2"	W17
2"	W27
2-1/2"	W32
3"	W37



Male Stems

Features

- Use with Boss® clamps on pages 26 and 27
- Hex dimension is the distance across the flats

- Recommended for steam service up to **450°F (232°C)**

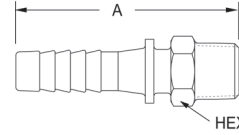

Hose x NPT Size	Dimensions		Plated Steel Bar Stock Part #
	A	Hex	
1/4" x 1/8"	2-1/4"	9/16"	MS4X2
1/4" x 1/4"	2-3/8"	9/16"	MSA
1/4" x 3/8"	2-7/16"	11/16"	MSB
3/8" x 1/4"	2-5/8"	11/16"	MS6X4
3/8" x 3/8"	2-11/16"	11/16"	MSC
3/8" x 1/2"	2-15/16"	7/8"	MS6X8
1/2" x 1/4"	3"	13/16"	MS8X4
1/2" x 3/8"	3"	7/8"	MS8X6
1/2" x 1/2"	3-3/16"	7/8"	MS1
1/2" x 3/4"	3-3/16"	1-1/8"	MS8X12
3/4" x 1/2"	4-3/32"	1-1/8"	MS12X8
3/4" x 3/4"	4-3/32"	1-1/8"	MS6
3/4" x 1"	4-11/32"	1-3/8"	MS12X16
1" x 3/4"	4-13/32"	1-3/8"	MS16X12
1" x 1"	4-19/32"	1-3/8"	MS11

Features

- Castings
- Use with Boss clamps on pages 26 and 27
- Hex dimension is the distance across the flats

Specification

- Recommended for steam service up to **450°F (232°C)**



plated iron



brass

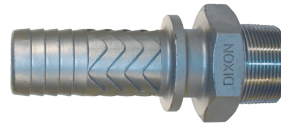

316 stainless

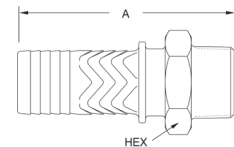

Hose x NPT Size	Dimensions		Plated Iron Part #	Brass Part #	316 Stainless Part #
	A	Hex			
1/2"	3-1/4"	7/8"	---	---	RMS1
3/4"	4-5/32"	1-1/8"	---	BMS6	RMS6
1"	4-21/32"	1-3/8"	---	BMS11	RMS11
1-1/4"	6-1/32"	2-1/8"	MS16	BMS16	RMS16
1-1/2"	6-5/16"	2-7/16"	MS21	BMS21	RMS21
2"	6-7/8"	2-7/8"	MS26	BMS26	RMS26
2-1/2"	8-5/8"	3-5/8"	MS31	---	RMS31
3"	9-1/2"	4-1/8"	MS36	BMS36	RLP36 ¹
4"	11"	5"	MS46	---	RLP46 ¹

¹ Schedule 40 stainless steel

Hose Menders

Features

- Collars engage grip fingers of Boss clamps

- 1/2" plated steel, 3/4" - 3": plated iron



Size	Dimension A	Part #	Size	Dimension A	Part #
1/2"	4"	M1	1-1/2"	8-3/8"	M21
3/4"	6"	M6	2"	9-1/16"	M26
1"	6-13/16"	M11	2-1/2"	10-1/2"	M31
1-1/4"	7-7/8"	M16	3"	11-7/8"	M36

Holedall® Fittings

Applications

- Designed for air and liquid applications where a permanent, low profile clamping system is desired
- Not for steam service 

Features

- Supplied with carbon steel ferrules
- Consult Dixon® for swage and/or crimp specifications

Size	Hose O.D.		Plated Iron/Steel Part #	Plated Iron/Steel Part # ²	Stainless Steel Part #
	From	To			
3/4"	1-10/64"	1-14/64"	GF26P1	GB6-P1	---
	1-15/64"	1-18/64"	GF26P2	GB6-P2	---
	1-19/64"	1-22/64"	GF26P3	GB6-P3	---
1"	1-30/64"	1-34/64"	GF36P1	GB11-P1	---
	1-35/64"	1-38/64"	GF36P2	GB11-P2	---
	1-39/64"	1-42/64"	GF36P3	GB11-P3	---
1-1/2"	1-58/64"	2"	GF61P1	GB21-P1	RGF61P1
	2-1/64"	2-8/64"	GF61P2	GB21-P2	RGF61P2
	2-9/64"	2-16/64"	GF61P3	GB21-P3	---
2"	2-28/64"	2-40/64"	GF81P1 ¹	GB26-P1	RGF81P1
	2-41/64"	2-48/64"	GF81P2 ¹	GB26-P2	RGF81P2
	2-49/64"	2-56/64"	GF81P3 ¹	GB26-P3	---
3"	3-30/64"	3-40/64"	GF111P1 ¹	GB36-P1	---
	3-41/64"	3-48/64"	GF111P2 ¹	GB36-P2	---
	3-49/64"	3-56/64"	GF111P3 ¹	GB36-P3	---

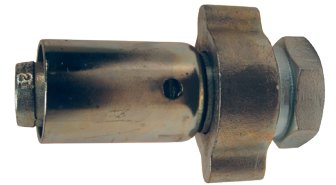

GF61P1



GB21-P1

¹ 2" and 3" have a machined shank

² Without spuds

Dimensions

Size	A	B
3/4"	4-3/4"	3-9/16"
1"	5-1/8"	3-9/16"
1-1/2"	7-1/16"	4-3/8"
2"	7-7/16"	5-5/8"
3"	8-13/16"	7-3/4"

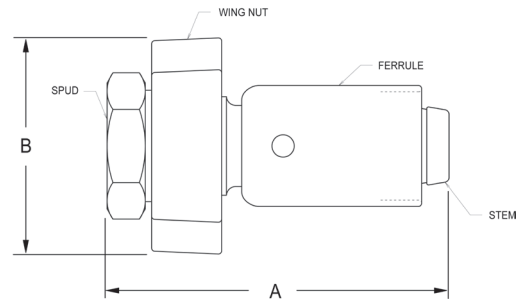

NOTE: 'A' dimension represents a complete coupling length with a female spud.
 'B' dimension is the largest dimension over the wing nut.

Adapters

Male NPT

Features

- Plated steel and/or iron
- Designed to fit the standard ground joint spuds on pages 17, 19, and 20
- Supplied with a wing nut, as shown
- For safety tags and safety tape, see page 55

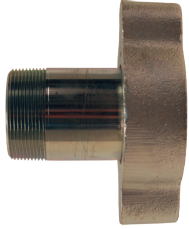

Size	Plated Steel and/or Iron Part #	316 Stainless Steel Part #
3/4"	GMAS6	RGMAS6
1"	GMAS11	---
1-1/4"	GMAS16	---
1-1/2"	GMAS21	---
2"	GMAS26 ¹	---
3"	GMAS36	---

¹ Uses a special wing nut, part # B27-1

Dimensions

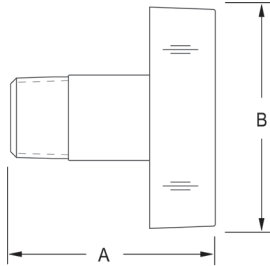

Size	A	B
3/4"	3-1/16"	3-9/16"
1"	3-5/16"	3-9/16"
1-1/4"	4"	4-1/4"
1-1/2"	4-1/8"	4-1/4"
2"	4-5/16"	5-5/8"

Female NPT



Size	Part #
3/4"	GFAS6
1"	GFAS11
1-1/4"	GFAS16
1-1/2"	GFAS21 ¹
2"	GFAS26
3"	GFAS36

¹ Part is produced as a welded fabrication

Dimensions

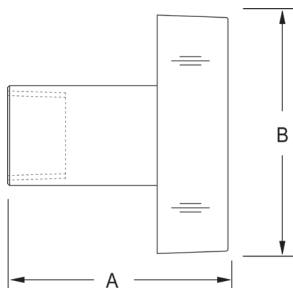

Size	A	B
3/4"	3-1/8"	3-9/16"
1"	3-5/16"	3-9/16"
1-1/4"	4"	4-1/4"
1-1/2"	3-25/32"	4-1/4"
2"	5"	5-5/8"

Wing Nut Caps

Features

- Plated steel and/or iron
- Supplied with 12" chain and washer
- For best results, use with washer style spuds and washers on page 16
- Boss® wing nut caps are not intended for pressure applications.



Size	Part #
3/4" and 1"	B12SC
1-1/4" and 1-1/2"	B17SC
2"	B27SC
3"	B37SC



Ground Joint Air Hammer Couplings

Features

- Rounded steel head of stem fits concave inserts in spuds for superior sealing
- Metal-to-metal copper seat seal
- Use with Boss clamps on pages 26 and 27

Female Spuds

Style	NPT Size	Plated Steel/Iron Part #
Compact	1/2"	GDF6
	3/4"	GDF8
Heavy duty	3/4"	GDF10
	1"	GDF12

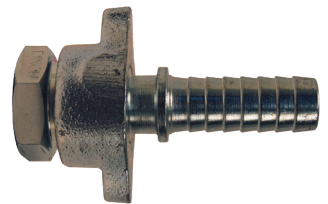

Dimensions

Style	Size	A	B
Compact	1/2"	4-5/32"	2-15/16"
	3/4"	4-15/16"	2-15/16"
Heavy	3/4"	5"	3-5/8"
	1"	5-13/32"	3-5/8"

NOTE: 'A' dimension represents a complete coupling length with a female spud
 'B' dimension is the largest dimension over the wing nut

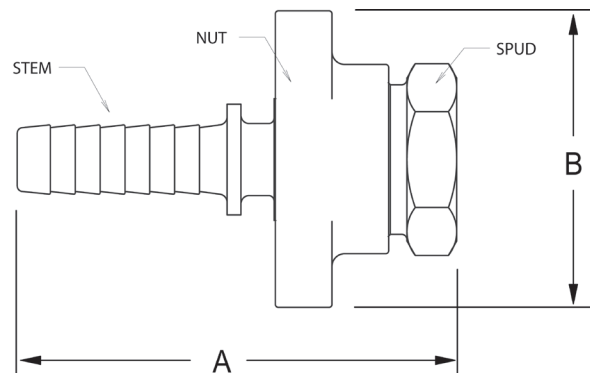

Stems

Style	Hose I.D.	Plated Steel Part #
Compact	1/2"	GBA45
	3/4"	GBA46
Heavy duty	3/4"	GBB18
	1"	GBB11



Ground Joint Air Hammer Couplings

Female Spuds



Style	NPT Size	Coarse Nut Thread	Plated Steel w/ Copper seat Part #
Compact	1/2"	1-31/64" O.D. x 8 TPI	GJ65
	3/4"		GJ55
Heavy duty	3/4"	1-47/64" O.D. x 8 TPI	GDL8
	1"		GDL13

Male Spuds

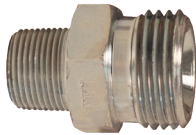

Style	Hose I.D. and NPT Sizes	Coarse Nut Thread	Plated Steel w/ Copper seat Part #
Compact	1/2"	1-31/64" O.D. x 8 TPI	GJ60
	3/4"		GJ50
Heavy duty	3/4"	1-47/64" O.D. x 8 TPI	GDL7
	1"		GDL10

Double Spuds



Style	Hose I.D. and NPT Sizes	Coarse Nut Thread	Plated Steel w/ Copper seat Part #
Compact	1/2"	1-31/64" O.D. x 8 TPI	GJ75
	3/4"		GJ75
Heavy duty	3/4"	1-47/64" O.D. x 8 TPI	GDL25
	1"		GDL25

Boss Clamps

⚠ WARNING

- The bolts used in the Boss interlocking clamps are not standard bolts. They vary from standard bolts in their length, diameter, overall thread length, and material hardness. These bolts can be retorqued, but it is not recommended that the bolts or clamps be reused, as they are designed for a single bend only. Dixon® recommends using only factory-supplied replacement bolts.
- Torque values for clamps are based on dry bolts. The use of lubricant on bolts will adversely effect clamp performance. Do not lubricate nuts and bolts.
- For all bolt tightening sequences, please visit dixonvalve.com

Feature

- Replacement nuts and bolts are available; contact Dixon for more information

Specifications

- Recommended for steam service up to 450°F (232°C)
- Recommended torque rating in ft. lbs.

2-Bolt Type, 2-Gripping Fingers

Hose I.D.	Hose O.D.		Zinc Plated Iron Part #	Pkg Qty	Stainless Steel ⁴ Part #	Torque ft. lbs. ²	Brass Part #	Torque ft. lbs.
	from	to						
1/4"	36/64"	42/64"	BD ³	100	---	6	---	---
3/8"	44/64"	56/64"	CD ³	100	---	6	---	---
	52/64"	60/64"	DD ³	100	---	6	---	---
1/2"	60/64"	1-4/64"	B4 ³	25	RB4	12	BB4	10
	1-4/64"	1-12/64"	B5	25	---	12	---	---
3/4"	1-10/64"	1-20/64"	BU9 ³	50	RBU9	21	BBU9	18
	1-20/64"	1-32/64"	B9	25	RB9	21	---	---
	1-32/64"	1-44/64"	B10 ³	25	---	21	---	---

**4-Bolt Type, 2-Gripping Fingers**

Hose I.D.	Hose O.D.		Zinc Plated Iron Part #	Pkg Qty	Stainless Steel ⁴ Part #	Torque ft. lbs. ²	Brass Part #	Torque ft. lbs.
	from	to						
1"	1-34/64"	1-46/64"	BU14	25	RBU14	21	BBU14	18
	1-44/64"	1-60/64"	B14	25	RB14	21	---	---
	1-60/64"	2-8/64"	B15	20	---	21	---	---
1-1/4"	1-32/64"	1-50/64"	BU18	20	---	40	---	---
	1-50/64"	2-6/64"	BU19	10	---	40	---	---
	2-8/64"	2-24/64"	B19	10	RB19	40	---	---
1-1/2"	1-52/64"	2"	BU22	10	---	40	---	---
	2"	2-14/64"	B22	10	---	40	---	---
	2-12/64"	2-24/64"	BU24	10	RBU24	40	---	---
2"	2-24/64"	2-36/64"	B24	10	RB24	40	---	---
	2-36/64"	2-48/64"	B25	10	---	40	---	---
	2-22/64"	2-34/64"	BU28	9	---	60	---	---
2-1/2"	2-32/64"	2-50/64"	BU29	10	RBU29	60	BBU29 ¹	40
	2-48/64"	3-4/64"	B29	10	RB29	60	---	---
	3-6/64"	3-28/64"	B30	5	---	60	---	---
3"	3-6/64"	3-28/64"	BU34	5	---	60	---	---
	3-32/64"	3-60/64"	B34	5	---	150	---	---
	3-32/64"	3-60/64"	BU35	5	RBU35	150	---	---
3"	3-52/64"	4-4/64"	B35	5	---	150	---	---
	4-4/64"	4-28/64"	B39	5	---	200	---	---



¹ Will become obsolete as inventory is depleted

² Torque applies to plated iron and stainless steel clamps

³ Global investment cast carbon steel (top table)

⁴ When installing stainless steel bolts and nuts, the use of anti-seize or anti-galling lubricant is advised. A light coat is required on the bolt threads to prevent thread galling and artificial torque reading.

Boss Clamps

⚠ WARNING

- The bolts used in the Boss interlocking clamps are not standard bolts. They vary from standard bolts in their length, diameter, overall thread length, and material hardness. These bolts can be retorqued, but it is **not** recommended that the bolts or clamps be reused, as they are designed for a single bend only. Dixon® recommends using only factory supplied replacement bolts.
- Torque values for clamps are based on dry bolts. The use of lubricant on bolts will adversely effect clamp performance. *Do not lubricate nuts and bolts.*
- For all bolt tightening sequences, please visit dixonvalve.com

Feature

- Replacement nuts and bolts are available; contact Dixon for more information

Specifications

- Recommended for steam service up to 450°F (232°C)
- Recommended torque rating in ft. lbs.

4-Bolt Type, 4-Gripping Fingers



Hose I.D.	Hose O.D.		Zinc Plated Iron Part #	Optional Qty	Torque ft. lbs.
	from	to			
1/2"	58/64"	1-2/64"	968	50	6
1"	1-26/64"	1-36/64"	156	20	21
1-1/4"	1-44/64"	1-56/64"	187	10	21
	1-56/64"	2-4/64"	206	20	21
1-1/2"	2"	2-8/64"	212	10	21
	2-4/64"	2-16/64"	225	10	40
2"	2-16/64"	2-32/64"	250 ¹	10	40
	2-32/64"	2-48/64"	275 ¹	10	40
	2-48/64"	3-4/64"	306 ¹	5	60
2-1/2"	3-4/64"	3-32/64"	350	5	60
	3-32/64"	3-48/64"	375	5	60
3"	3-48/64"	4"	401	5	150
	4"	4-12/64"	418	2	200
	4-12/64"	4-32/64"	450	2	200

¹ Not to be used with GF81, GB26, WF81, B26, RGF81, RGB26, BGF81, RWF81, RB26



6-Bolt Type, 3-Gripping Fingers



Hose I.D.	Hose O.D.		Zinc Plated Iron Part #	Optional Qty	Torque ft. lbs.
	from	to			
3"	4-16/64"	4-52/64"	BS39	2	150
	4-40/64"	5"	B45	3	150
4"	4-56/64"	5-16/64"	BS49	2	200
	5-16/64"	5-38/64"	BU49	2	200
	5-34/64"	5-60/64"	B49	2	200

6 Bolt Type, 6 Gripping Fingers



Hose I.D.	Hose O.D.		Zinc Plated Iron Part #	Optional Qty	Torque ft. lbs.
	from	to			
6"	6-56/64"	7-24/64"	750	1	200
	7-32/64"	8"	850	1	200

Dix-Lock N-Series Quick Acting Couplings

Features

- Dual-guide sleeve tabs ensure smooth action
 - Corrosion resistant coatings and materials improve performance
 - Pneumatically energized seal for optimal performance at a variety of pressures
 - Wide variety of end configurations
 - Connecting: convenient push-twist and click
 - Disconnecting: retract sleeve, twist and pull
- Never attempt to disconnect any hose while pressure is in the line.



Materials

- Female and male bodies: Trivalent Chrome plated steel
optional - brass or 303 stainless steel
- Sleeve: zinc die cast
optional - brass or 303 stainless steel
- Retaining ring and spring: stainless steel
- Seal: nitrile rubber
optional - FKM

Specifications

- Pressure: **300 PSI** in brass; **500 PSI** in steel, 303 stainless steel at ambient temperature **70°F (21°C)**
- The operating temperature range is **-40°F to 250°F (-40°C to 121°C)**.

Interchange

- Interchanges with MIL-C-3486 and A-A-50431A standards
- Interchanges with Bowes 51000-Series and National Series-B

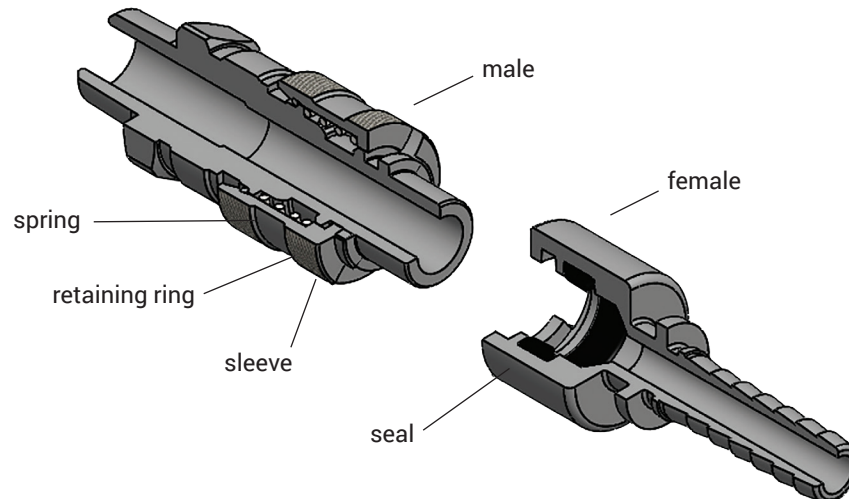

Dix-Lock N-Series Bowes Interchange Plug Standard Hose Barbs



brass



steel



303 stainless

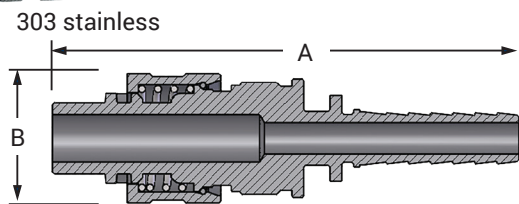

Body Size	Hose I.D.	Brass		Steel		303 Stainless Steel	
		Previous Part #	Part #	Previous Part #	Part #	Previous Part #	Part #
3/8"	1/2"	---	---	QM1	N3CS4	---	---
	3/8"	QB2	N4S3-B	QM2	N4S3	---	---
1/2"	1/2"	QB3	N4S4-B	QM3	N4S4	---	---
	3/4"	QB4	N4S6-B	QM4	N4S6	QSS4	N4S6-S
	1"	QB5	N4S8-B	QM5	N4S8	---	N4S8-S

Dimensions

Body Size	Hose Shank	A	B
3/8"	1/2"	4.74	0.99
	3/8"	4.54	1.37
1/2"	1/2"	4.95	1.37
	3/4"	4.95	1.37
	1"	5.77	1.37

Dix-Lock N-Series Bowes Interchange Coupler Standard Hose Barbs



brass



steel



303 stainless

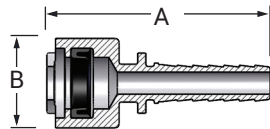

Body Size	Hose I.D.	Brass		Steel		303 Stainless Steel	
		Previous Part #	Part #	Previous Part #	Part #	Previous Part #	Part #
3/8"	1/2"	---	---	QM20	3NCS4	---	---
	3/8"	QB21	4NS3-B	QM21	4NS3	---	---
1/2"	1/2"	QB22	4NS4-B	QM22	4NS4	---	---
	3/4"	QB23	4NS6-B	QM23	4NS6	QSS23	4NS6-S
	1"	QB25	4NS8-B	QM25	4NS8	---	4NS8-S

Dimensions

Body Size	Hose Shank	A	B
3/8"	1/2"	3.40	0.97
	3/8"	2.97	1.35
1/2"	1/2"	3.39	1.35
	3/4"	3.39	1.35
	1"	4.20	1.35

Dix-Lock N-Series Bowes Interchange Plug Male Thread



brass



steel



303 stainless

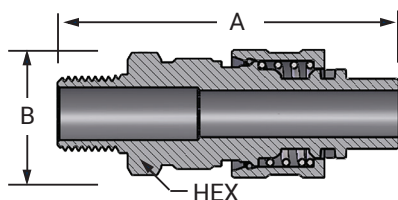

Body Size	Threads	Brass		Steel		303 Stainless Steel	
		Previous Part #	Part #	Previous Part #	Part #	Previous Part #	Part #
3/8"	1/2"-14 NPTF	---	---	QM40	N3M4	---	---
	1/2"-14 BSPT	---	---	---	N3BM4	---	---
	3/8"-18 NPTF	QB41	N4M3-B	QM41	N4M3	---	---
	3/8"-19 BSPT	---	---	---	N4BM3	---	---
1/2"	1/2"-14 NPTF	QB42	N4M4-B	QM42	N4M4	---	---
	1/2"-14 BSPT	---	N4BM4-B	---	N4BM4	---	---
	3/4"-14 NPTF	QB43	N4M6-B	QM43	N4M6	QSS43	N4M6-S
	3/4"-14 BSPT	---	N4BM6-B	---	N4BM6	---	---
	1"-11-1/2 NPTF	QB45	N4M8-B	QM45	N4M8	---	---
1"-11 BSPT	---	N4BM8-B	---	N4BM8	---	---	

Dimensions

Body Size	Threads	A	B	Hex
3/8"	1/2"	3.36	0.99	1-3/16"
	3/8"	3.46	1.37	1-1/8"
1/2"	1/2"	3.65	1.37	1-1/8"
	3/4"	3.65	1.37	1-1/8"
	1"	3.89	1.37	1-3/8"

Dix-Lock N-Series Bowes Coupler Male Thread

Body Size	Threads	Brass		Steel		303 Stainless Steel	
		Previous Part #	Part #	Previous Part #	Part #	Previous Part #	Part #
3/8"	1/2"-14 NPTF	---	---	QM60	3NM4	---	---
	1/2"-14 BSPT	---	---	---	3NBM4	---	---
	3/8"-18 NPTF	QB61	4NM3-B	QM61	4NM3	---	---
1/2"	3/8"-19 BSPT	---	---	---	4NBM3	---	---
	1/2"-14 NPTF	QB62	4NM4-B	QM62	4NM4	---	---
	1/2"-14 BSPT	---	4NBM4-B	---	4NBM4	---	---
	3/4"-14 NPTF	QB63	4NM6-B	QM63	4NM6	QSS63	4NM6-S
	3/4"-14 BSPT	---	4NBM6-B	---	4NBM6	---	---
	1"-11-1/2 NPTF	QB65	4NM8-B	QM65	4NM8	---	---
	1"-11 BSPT	---	4NBM8-B	---	4NBM8	---	---

Dimensions

Body Size	Threads	A	B	Hex
3/8"	1/2"	1.80	1.10	1-3/16"
	3/8"	1.66	1.50	1-3/8"
1/2"	1/2"	1.85	1.50	1-3/8"
	3/4"	1.85	1.50	1-3/8"
	1"	1.95	1.50	1-1/2"

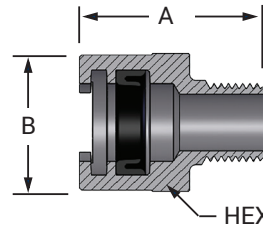

brass



steel



303 stainless

Dix-Lock N-Series Bowes Plug Female Thread

Body Size	Threads	Brass		Steel		303 Stainless Steel	
		Previous Part #	Part #	Previous Part #	Part #	Previous Part #	Part #
3/8"	3/8"-18 NPTF	QB81	N4F3-B	QM81	N4F3	---	---
	3/8"-19 BSPP	---	---	---	N4BF3	---	---
	1/2"-14 NPTF	QB82	N4F4-B	QM82	N4F4	---	---
1/2"	1/2"-14 BSPP	---	N4BF4-B	---	N4BF4	---	---
	3/4"-14 NPTF	QB83	N4F6-B	QM83	N4F6	QSS83	N4F6-S
	3/4"-14 BSPP	---	N4BF6-B	---	N4BF6	---	---
	1"-11-1/2 NPTF	QB85	N4F8-B	QM85	N4F8	---	---
	1"-11 BSPP	---	N4BF8-B	---	N4BF8	---	---

Dimensions

Body Size	Threads	A	B	Hex
1/2"	3/8"	2.92	1.35	1-1/8"
	1/2"	2.92	1.35	1-1/8"
	3/4"	3.42	1.35	1-3/8"
	1"	3.59	1.35	1-1/2"

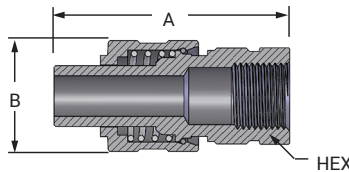

brass



steel



303 stainless

Dix-Lock N-Series Bowes Coupler Female Thread

Body Size	Threads	Brass		Steel		303 Stainless Steel	
		Previous Part #	Part #	Previous Part #	Part #	Previous Part #	Part #
3/8"	3/8"-18 NPTF	QB101	4NF3-B	QM101	4NF3	---	---
	3/8"-19 BSPP	---	---	---	4NBF3	---	---
	1/2"-14 NPTF	QB102	4NF4-B	QM102	4NF4	---	---
1/2"	1/2"-14 BSPP	---	4NBF4-B	---	4NBF4	---	---
	3/4"-14 NPTF	QB103	4NF6-B	QM103	4NF6	QSS103	4NF6-S
	3/4"-14 BSPP	---	4NBF6-B	---	4NBF6	---	---
	1"-11-1/2 NPTF	QB105	4NF8-B	QM105	4NF8	---	---
	1"-11 BSPP	---	4NBF8-B	---	4NBF8	---	---

Dimensions

Body Size	Threads	A	B	Hex
1/2"	3/8"	1.71	1.50	1-3/8"
1/2"	1/2"	1.71	1.50	1-3/8"
1/2"	3/4"	1.71	1.50	1-3/8"
1/2"	1"	1.86	1.79	1-1/2"

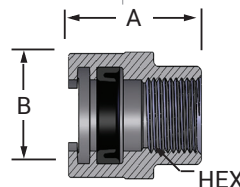

brass



steel



303 stainless

Dix-Lock N-Series Bowes Interchange Safety-Lock Hose Barb Plugs



brass



steel



303 stainless

Feature

- Positive safety lock; with locking nut in place sleeve cannot be moved to open coupling



Body Size	Hose I.D.	Brass		Steel		303 Stainless Steel Part #
		Previous Part #	Part #	Previous Part #	Part #	
1/2"	1/2"	QB33	N4S4-B-LS	QM33	N4S4-LS	---
	3/4"	QB44	N4S6-B-LS	QM44	N4S6-LS	N4S6-S-LS

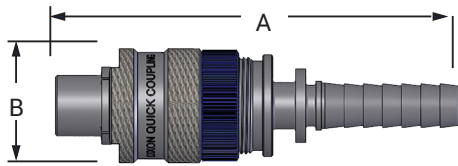

Dimensions

Body Size	Hose Shank	A	B
3/8"	1/2"	4.95	1.37
1/2"	3/4"	4.95	1.37

Dix-Lock N-Series Bowes Interchange Male Safety-Lock Plugs



brass



steel



303 stainless

Feature

- Positive safety lock; with locking nut in place sleeve cannot be moved to open coupling



Body Size	Threads	Brass		Steel		303 Stainless Steel Part #
		Previous Part #	Part #	Previous Part #	Part #	
1/2"	1/2"-14 NPTF	QB66	N4M4-B-LS	QM66	N4M4-LS	---
	1/2"-14 BSPT	---	---	---	N4BM4-LS	---
	3/4"-14 NPTF	QB88	N4M6-B-LS	QM88	N4M6-LS	N4M6-S-LS
	3/4"-14 BSPT	---	---	---	N4BM6-LS	---



Dimensions

Body Size	Threads	A	B
3/4"	1/2"	3.65	1.37
1/2"	3/4"	3.65	1.37

Dix-Lock N-Series Bowes Interchange Caps

Body Size	Cap Lanyard	Brass		Steel	
		Previous Part #	Part #	Previous Part #	Part #
1/2"	steel cable	QBCAP	N4DC-B	QMCAP	N4DC



Dix-Lock N-Series Bowes Interchange Converter

Body Size	Configuration	Steel	
		Previous Part #	Part #
1/2"	coupler to coupler	QM0	4N4N



Dix-Lock N-Series Bowes Interchange Seals

Body Size	Coupler Style	Nitrile		FKM
		Previous Part #	Part #	Part #
3/8"	all	QBM1	3N-SKIT	---
1/2"	all	QBM2	4N-SKIT	F-4N-SKIT



Features

- Working pressure: **300 PSI** at ambient temperature **70°F (21°C)**
- For crimp recommendations please visit dixonvalve.com
- Also available in stainless steel, contact Dixon® for further information

Materials

- Machined components are manufactured using solid steel, brass, or 303 stainless steel bar stock
- Stainless steel retaining ring and spring maximize corrosion resistance and extend service life
- Steel componentry is plated using ROHS Compliant Trivalent Chrome

Interchange Data

- Boves Interchange Bayonet Style
- Interchangeable with Boves 51000-Series, National Series 'B' and MacDonald Quick-Action

Seal Components

- Nitrile rubber pneumatically energized seals are standard, temperature range **-40°F to 250°F (-40°C to 121°C)**.

Dix-Lock N-Series Boves Interchange Coupling with Ferrule Male Head



Body Size	Hose I.D.	Hose O.D.		Plated Steel		Brass	
		From:	To:	Previous Part #	Part #	Previous Part #	Part #
1/2"	1/2"	5/16"	1-2/64"	QM3WF	N4S4-WF	QB3WF	N4S4-B-WF
	3/4"	1-10/64"	1-22/64"	QM4WF	N4S6-WF	QB4WF	N4S6-B-WF

Dix-Lock N-Series Boves Interchange Coupling with Ferrule Female Head



Body Size	Hose I.D.	Hose O.D.		Plated Steel		Brass	
		From:	To:	Previous Part #	Part #	Previous Part #	Part #
1/2"	1/2"	5/16"	1-2/64"	QM22WF	4NS4-WF	QB22WF	4NS4-B-WF
	3/4"	1-10/64"	1-22/64"	QM23WF	4NS6-WF	QB23WF	4NS6-B-WF

Dix-Lock N-Series Boves Interchange Coupling with Ferrule Male Locking Head

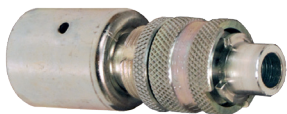

Body Size	Hose I.D.	Hose O.D.		Plated Steel		Brass	
		From:	To:	Previous Part #	Part #	Previous Part #	Part #
1/2"	1/2"	5/16"	1-2/64"	QM33WF	N4S4-LS-WF	QB33WF	N4S4-B-LS-WF
	3/4"	1-10/64"	1-22/64"	QM44WF	N4S6-LS-WF	QB44WF	N4S6-B-LS-WF

Dual-Lock P-Series Quick Acting Couplings

Features

- Spring loaded interlocking engagement
 - Full opening permits full flow to tool
 - Optional locking key prevents sleeve retraction
 - Trivalent chrome plated
 - Connecting: push and twist
 - Locking clip is available to prevent unintentional disconnection
 - Disconnecting: pull and twist
- Never attempt to disconnect any hose while pressure is in the line 

Materials

- Body: Trivalent Chrome plated steel
optional - brass or 303 stainless steel
- Sleeve: steel
optional - brass or 303 stainless steel
- Retaining ring and spring: phosphor bronze
- Seal: nitrile rubber
optional - FKM

Specifications

- The recommended working pressure: **300 PSI** at ambient temperature **70°F (21°C)**
- The operating temperature range is **-40°F to 250°F (-40°C to 121°C)**

Interchange

- Interchangeable with Thor PHC-Series and National Series-A

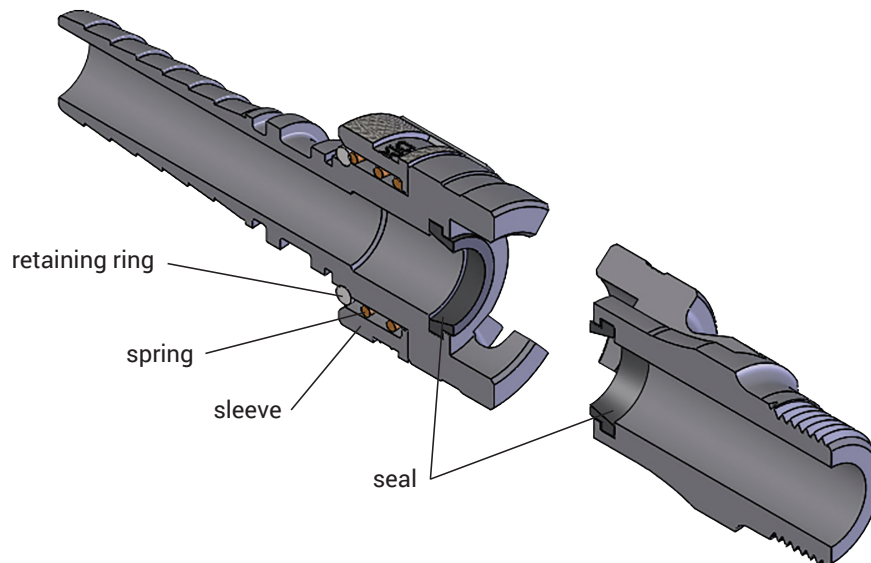

Dual-Lock P-Series Thor Interchange Coupler Hose Barb Couplers



Body Size	Hose I.D.	Brass		Steel		303 Stainless Steel	
		Previous Part #	Part #	Previous Part #	Part #	Previous Part #	Part #
1/2"	3/8"	---	---	PHL6	4PS3	---	---
	1/2"	---	4PS4-B	PHL8	4PS4	---	---
	3/4"	PHLB12	4PS6-B	PHL12	4PS6	PHL12SS	4PS6-S
	3/4"	---	---	---	4PS6-9 ¹	---	---
	1"	PHLB16	4PS8-B	PHL16	4PS8	---	---

¹ Steel/PTFE coating

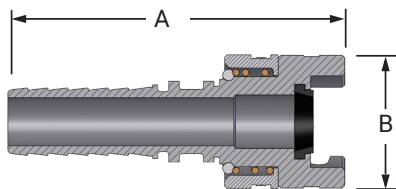

Dimensions

Size	A	B
3/8"	3.53"	1.55"
1/2"	3.95"	1.55"
3/4"	3.95"	1.55"
1"	6.06"	1.55"

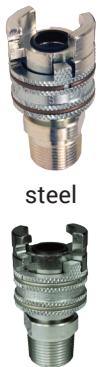

Dual-Lock P-Series Thor Interchange Male Couplers

Body Size	Threads	Steel		303 Stainless Steel	
		Previous Part #	Part #	Previous Part #	Part #
1/2"	3/8"-18 NPTF	PML6	4PM3	---	---
	1/2"-14 NPTF	PML8	4PM4	---	---
	3/4"-14 NPTF	PML12	4PM6	PML12SS	4PM6-S
	3/4"-14 NPTF	---	4PM6-9 ¹	---	---
	1"-11 1/2 NPTF	---	4PM8	---	---

¹ Steel/PTFE coating

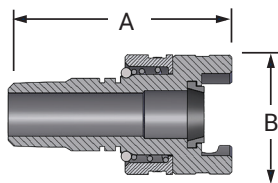

Dimensions

Size	A	B
1/2"	2.93"	1.55"
3/4"	2.98"	1.55"
1"	2.98"	1.55"



Dual-Lock P-Series Thor Interchange Female Couplers

Body Size	Threads	Brass Part #	Steel		303 Stainless Steel	
			Previous Part #	Part #	Previous Part #	Part #
1/2"	1/2" - 14 NPTF	---	PFL8	4PF4	---	---
	3/4" - 14 NPTF	4PF6-B	PFL12	4PF6	PFL12SS	4PF6-S

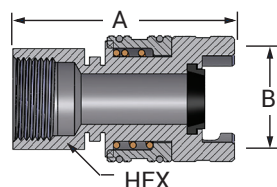

Dimensions

Size	A	B	Hex
1/2"	2.75"	1.55"	1.25"
3/4"	2.75"	1.55"	1.25"

Dual-Lock P-Series Thor Interchange Male Plugs

Body Size	Threads	Brass		Steel		303 Stainless Steel	
		Previous Part #	Part #	Previous Part #	Part #	Previous Part #	Part #
1/2"	3/8"-18 NPTF	---	---	PM6	P4M3	---	---
	1/2"-14 NPTF	PMB8	P4M4-B	PM8	P4M4	---	---
	3/4"-14 NPTF	PMB12	P4M6-B	PM12	P4M6	PM12SS	P4M6-S
	3/4"-14 NPTF	---	---	---	P4M6-9 ¹	---	---
	1"-11-1/2 NPTF	PMB16	P4M8-B	PM16	P4M8	---	---

¹ Steel/PTFE coating

Dimensions

Size	A	B	Flat
3/8"	2.00"	1.55"	0.88"
1/2"	2.25"	1.55"	0.97"
3/4"	2.55"	1.55"	1.13"
1"	3.25"	1.55"	1.38"

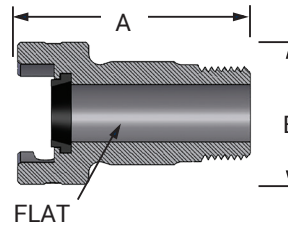

Must be used with couplers on page 28

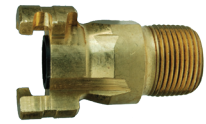

brass

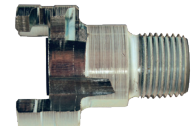

steel



303 stainless

Dual-Lock P-Series Thor Interchange Female Plugs

Body Size	Threads	Brass		Steel		303 Stainless Steel	
		Previous Part #	Part #	Previous Part #	Part #	Previous Part #	Part #
1/2"	3/8"-18 NPTF	---	---	PF6	P4F3	---	---
	1/2"-14 NPTF	PFB8	P4F4-B	PF8	P4F4	---	---
	3/4"-14 NPTF	PFB12	P4F6-B	PF12	P4F6	PF12SS	P4F6-S
	3/4"-14 NPTF	---	---	---	P4F6-9 ¹	---	---
	1"-11-1/2 NPTF	PFB16	P4F8-B	PF16	P4F8	---	---

¹ Steel/PTFE coating

Dimensions

Size	A	B	Flat
3/8"	1.79"	1.55"	0.88"
1/2"	2.25"	1.55"	1.31"
3/4"	2.34"	1.55"	1.31"
1"	2.76"	1.55"	1.44"

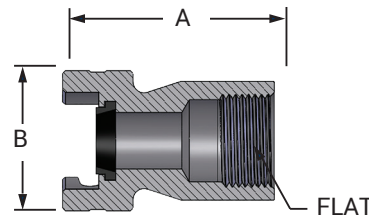

NOTE: Must be used with couplers on page 28



brass



steel



303 stainless

Dual-Lock P-Series Thor Interchange Hose Barb Couplers with Knurled Flanged Sleeve

Features

- Trivalent Chrome plated
- Large, raised collar sleeve permits easier handling when wearing gloves.

Body Size	Hose I.D.	Trivalent Chrome Plated Steel	
		Previous Part #	Part #
1/2"	3/8"	PHL6FS	4PS3-FS
	1/2"	PHL8FS	4PS4-FS
	3/4"	PHL12FS	4PS6-FS

Dimensions

Size	A	B
3/8"	3.53"	1.55"
1/2"	3.95"	1.55"
3/4"	3.95"	1.55"

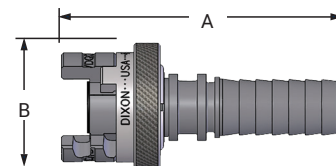

Dual-Lock P-Series Thor Interchange Male Couplers with Knurled Flanged Sleeve

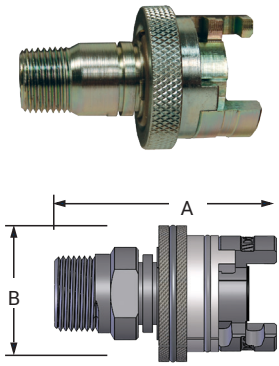

Features

- Trivalent Chrome plated
- Large, raised collar sleeve permits easier handling when wearing gloves

Body Size	Threads	Trivalent Chrome Plated Steel	
		Previous Part #	Part #
1/2"	3/8" - 18	PML6FS	4PM3-FS
	1/2" - 14	PML8FS	4PM4-FS
	3/4" - 14	PML12FS	4PM6-FS

Dimensions

Size	A	B
3/8"	2.93"	1.55"
1/2"	2.98"	1.55"
3/4"	2.98"	1.55"

Dual-Lock P-Series Thor Interchange Female Couplers with Knurled Flanged Sleeve

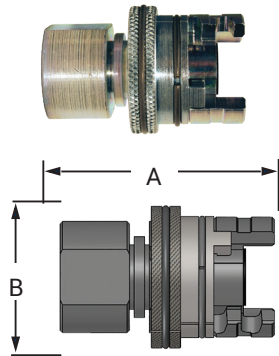

Feature

- Large, raised collar sleeve permits easier handling when wearing gloves.

Body Size	Threads	Trivalent Chrome Plated Steel	
		Previous Part #	Part #
1/2"	1/2" - 14	PFL8FS	4PF4-FS
	3/4" - 14	PFL12FS	4PF6-FS

Dimensions

Size	A	B
1/2"	2.75"	1.55"
3/4"	2.75"	1.55"

Dual-Lock P-Series Thor Interchange Replacement Seals



Body Size	Coupler Style	Nitrile Part #	FKM	
			Previous Part #	Part #
1/2"	all	4P-SKIT	452963	F-4P-SKIT

Thor Interchange Locking Key

Features

- Fits couplings with locking sleeve
- Prevents sleeve retraction



Body Size	Coupler Style	Steel	
		Previous Part #	Part #
1/2"	all	855231	4P-CLIP

Dual-Lock P-Series Thor Interchange Couplers with Ferrule

Features

- Working pressure: **300 PSI** at ambient temperature **70°F (21°C)**
- Trivalent Chrome plated coupling with plated steel ferrule
- Also available in brass and stainless steel
- For crimp recommendations visit dixonvalve.com
- 3/8" and 1" sizes available upon request, contact Dixon®



Body Size	Hose I.D.	Hose O.D.		Trivalent Chrome Plated Steel	
		From:	To:	Previous Part #	Part #
1/2"	1/2"	54/64"	1-2/64"	PHL8WF	4PS4-WF
	3/4"	1-10/64"	1-22/64"	PHL12WF	4PS6-WF

Air Receiver Manifold Assembly

Part # 1217AR-4AK

Tank provides (1) 2" Ground Joint inlet for supply hose and (7) 3/4" outlets for tool hoses

Features

- All tank outlets have female NPT threads
- Portable - easy carry handles standard
- Solid base with mounting holes standard
- Approximate tank dimensions are 12" x 17"; 40" x 24" with frame
- Painted safety orange
- Spring-loaded safety shut-off valves (cut-off flow rate 160-180 CFM at 90 PSI)
- Safety Pop-off valve (**200 PSI**) to protect against over-pressurizing of tank
- Drain valve provides for removal of accumulated oil and water
- Locking handle ball valve
- Mounting points for King Safety Whipsocks

Specifications

- 7 gallon capacity provides air reserve needed for operation of tools
- **200 PSI** maximum working pressure for tank (*Working pressure of the system is limited to maximum working pressure of the components, i.e. 150 PSI for Air King®*)
- **0-300 PSI** gauge



Approvals

- Built to ASME Code, National Board registered
- Conforms to OSHA Standards 1910.169 and 1926.306



1217AR-4AK



1217AR-4FR

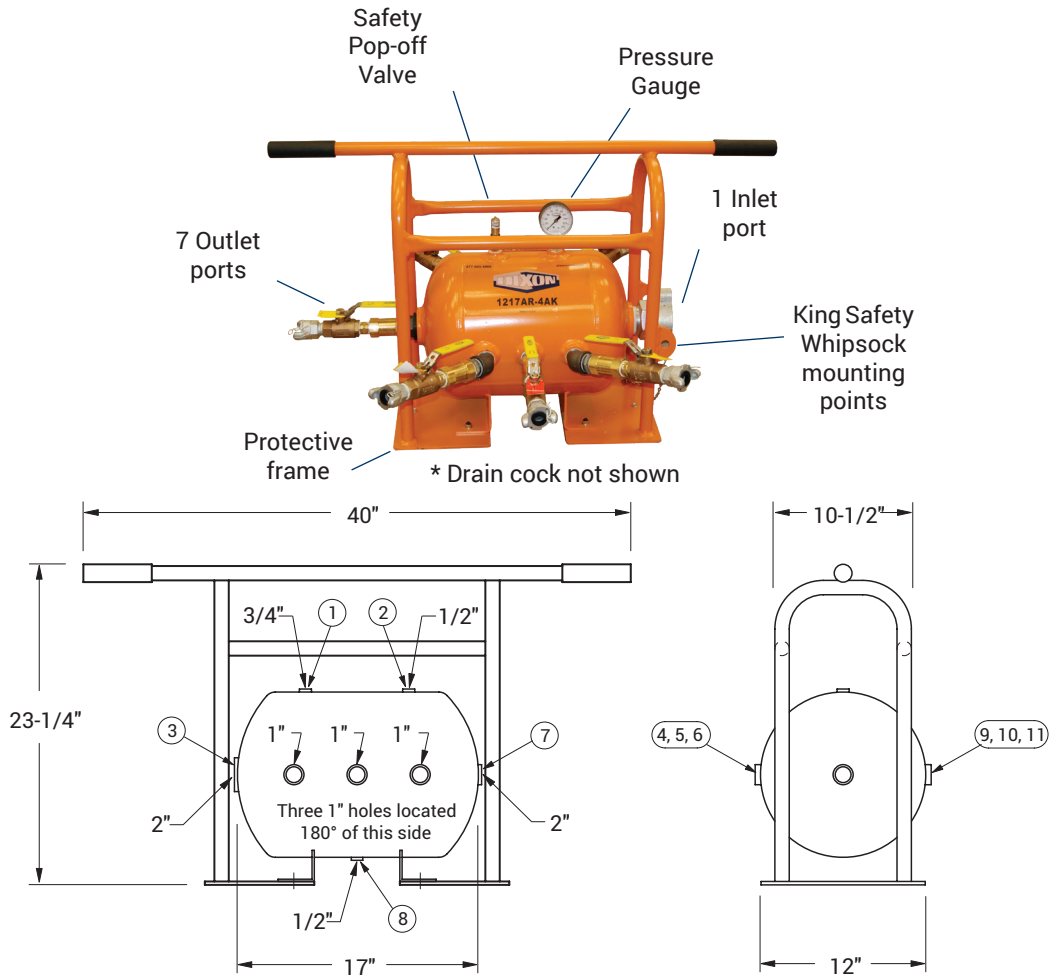

Dixon® 1217AR-4AK air receiver manifold assembly with Air King® outlet ports includes the following components:

Part #/Locations	Qty	Description
1217AR-4	1	ASME compressed air receiver
1217FRAME	1	protective frame
Location 1	1	HB2F6M 3/4" male x 1/4" female hex bushing
	1	GL345 0-300 PSI gauge
Location 2	1	HB2F4M 1/2" male x 1/4" female hex bushing
	1	SV200 safety pop-off valve
Location 3	1	GM28 2" male spud
	1	B27SC wing nut cap
	6	HB1075G 1" male x 3/4" female bushings
Locations 4, 5, 6, 9, 10, 11	6	BCN75 3/4" brass hex nipples
	6	BBLV75 ball valves
	6	SCVS6 safety shut-off valves
	6	AM7 Air King universal couplings
	4	SE45100 45° street elbow (1 each in locations 4, 6, 9 and 11 only)
	1	HB2075 2" male x 3/4" female bushing
Location 7	1	BCN75 3/4" brass hex nipples
	1	BBLV75 ball valve
	1	SCVS6 safety shut-off valve
	1	AM7 Air King universal coupling
Location 8	1	HB2F4M 1/2" male x 1/4" female hex bushing
	1	D04 1/4" drain cock
	---	Labor cost for assembly of complete unit
1217AR-4AK	1	7 gallon ASME compressed air receiver manifold complete assembly with Air King
Tank and Frame only		
1217AR-4FR	1	7 gallon ASME compressed air receiver with frame only

Dixon recommends the use of safety clips and King safety cables on all air hose connections.



ASME Air Receiver Manifold with King Safety Whipsock for Supply Hose

Features

- Built to ASME Code, National Board registered
- Conforms to OSHA standards 1910, 169 and 1926.306
- 7 gallon capacity
- Painted safety orange
- All openings are female NPT thread
- Working pressure: **200 PSI**
- Includes KSW32 2" King Safety Whipsock for air supply hose
- Shackles included to attach King Safety Whipsock to frame



Qty	Part #
1"	1217AR-4AK-KSW

ASME Air Tank with Fittings and Watts Filter

Application

- Designed to remove compressed air contaminants such as water, compressor oil, dirt, pipe scale and water particles from the air supply at the point of entry into the ASME air receiver manifold.

Features

- Includes basic 1217AR-4AK ASME manifold assembly
- F602-16WJR 2" auto drain filter with 26 ounce metal bowl and related plumbing installed on the inlet port of the ASME air receiver manifold
- Air supply hose connects directly to GM28 2" male spud on the filter air inlet
- Includes a B27SC wing nut cap with a chain



Inlet	Outlet	Part #
2"	3/4"	1217AR-4AKWF

Wilkerson Combination Unit with Protective Frame

Features

- Provides downstream air preparation with protective frame
- C31-08AMB 1" FRL with metal bowls and auto drain filter
- FBV100 1" brass ball valve and AM12 Air King® on inlet port
- BBV100DTW 2-way ball valve installed between regulator and lubricator provides option for non-lubricated air
- Heavy duty frame protects air prep components
- Operating:
 - Maximum pressure: **250 PSIG**
 - Temperature range: **40°F to 150°F (4°C to 66°C)**
 - Flow: 320 SCFM



Size	Part #
1"	C31-08FRAME

Safety Check Valve

Features

- Does not prevent backflow
- High flow valve to provide optimum performance
- Controls excess air flow (SCFM) in only one direction
- Not for use in applications where 100% of the available air is required, i.e. sand blast, pile driving rigs, expansion joint blow down pipes, etc.
- Automatically senses change in air flow and shuts off the flow in the event of a surge in excess of valve flow rating thus preventing hose whip
- Conforms to OSHA regulation 1926.302 (b) (7) requiring a safety device at the source of the air supply and at branch air lines.
- Applications include temporary plant/factory air, construction sites, shipyards or utilities

Materials

- Solid brass body and valve
- Stainless steel spring and roll pin

Specifications

- Maximum working pressure: **350 PSI**
- Maximum temperature: **250°F (121°C)**
- Safety Check Valves operate by using the pressure differential across the valve to operate the valve and spring assembly. The pressure differential is directly related to the flow of air through the valve.
- When the pressure differential is within the operating limits -- below the cutoff flow -- of the unit, the force on the valve exerted by the spring is greater than that caused by the pressure differential (see open position graphic below). The valve remains open and normal operation continues.
- When the pressure differential is above the cutoff limit, the force on the valve exerted by the pressure differential is greater than the force exerted by the spring, and the valve closes (see the closed position graphic below).
- After the repair is made, normal operation is automatically enabled when pressure across the valve equalizes through the bleeder hole.
- The valve spring size can be specified by determining the air flow during normal operation and by estimating the air flow if a failure or rupture occurs.

Questions to ask when selecting a safety shut-off valve

1. What is the hose I.D. size you are using?
2. What is the operating pressure of the compressor, in PSI?
3. What is the SCFM of your compressor? (printed on the side of most air compressors)
4. How much air flow, in SCFM, does the tool(s) require?
5. What is the maximum air flow possible, in SCFM, through your air hose, at the end of the length of the hose?
Contact Dixon® for recommendations if the hose length is over 100'.

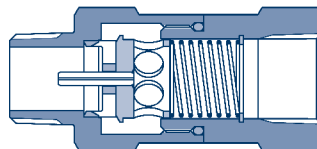
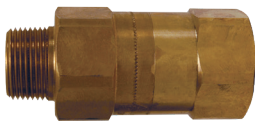

Check Valve In Open Position

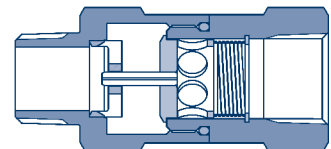

Check Valve In Closed Position

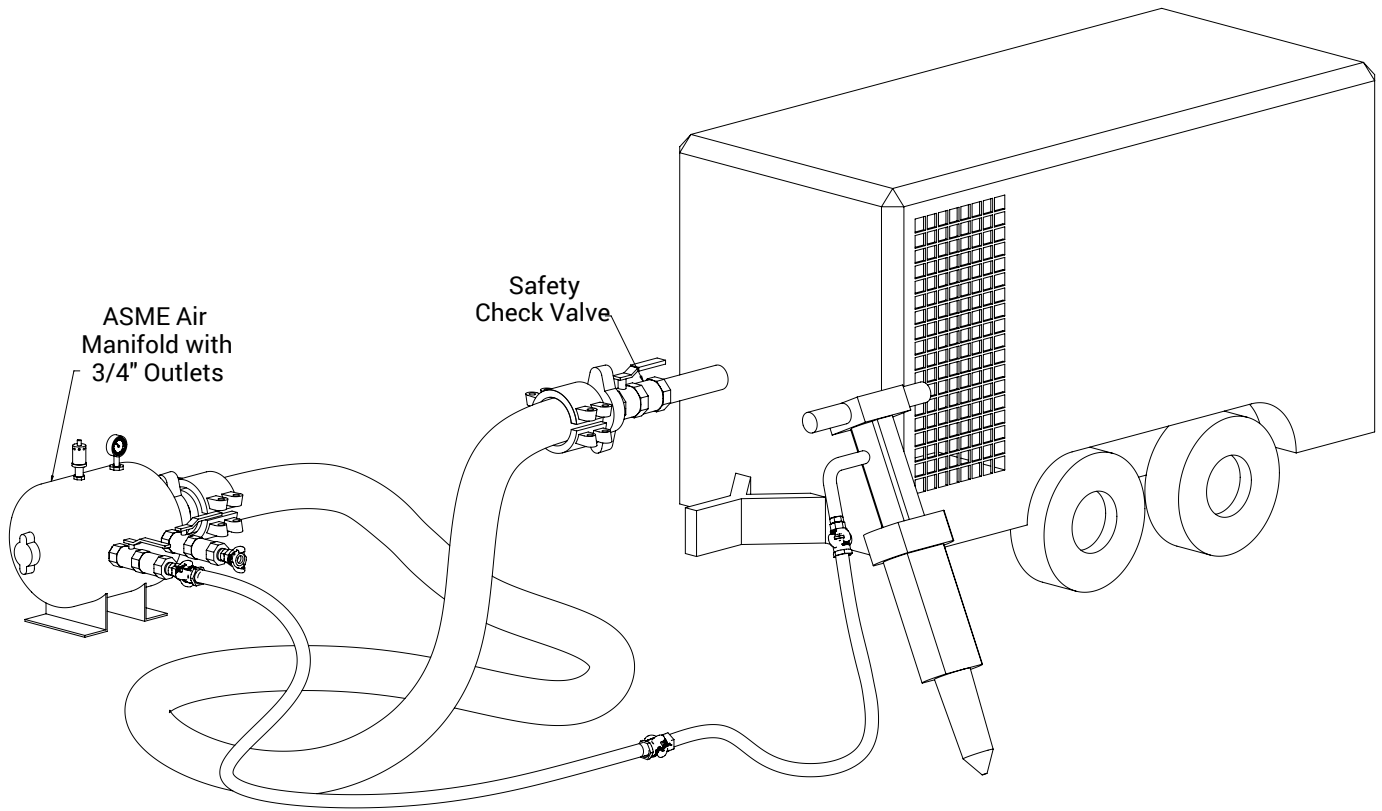

Installation

A safety shut-off valve should be placed immediately after the air control valve and before the hose on a compressor, and on each discharge port on a manifold (see drawing above).

Sizing the safety shut-off valve

1. The safety shut-off valve NPT size must be the same as the nominal I.D. size of the air line on which it is used.
NOTE: Never increase or decrease the hose size from the compressor to the tool or from the compressor to the manifold.
2. One safety shut-off valve must be used on each hose outlet from the manifold.
3. To avoid nuisance cut-off's, the shut-off valve selected should have a cut-off range of 110% of the maximum anticipated air flow to the tool, or tools, to be used.
4. The maximum SCFM of the supply side air line must be above the cut-off range of the valve. The cut-off range of Dixon®'s shut-off valves is given at **90 PSI**. To determine the cut-off range at other PSI's, use the formula or the sample numbers in the Cut-off Rate Chart below to find the flow rate multiplier. Multiply the flow rate multiplier by the numbers in the cut-off flow range column to find the cut-off range at your PSI.

**Safety Shut-off Valve Cut-off Rates
at PSI's Other Than 90 PSI**

$$\text{Flow rate multiplier} = \sqrt{\frac{\text{PSIG} + 14.7}{104.7}}$$

Inlet pressure (PSI)	25	50	75	100	125
Flow rate multiplier	.62	.79	.93	1.05	1.16

Operation

Before starting the compressor the air control valve should be closed completely. When the compressor unloads, open the air control valve very slowly. Full port ball valves tend to work better than gate or butterfly type valves.

The air control valve must be fully open for the safety shut-off valve to work. Some portable air compressor manufacturers recommend start-up with the air control valve slightly open. In this case you may have to close the valve and reopen it slowly to the full open position, or wait for the safety shut-off valve to reset itself.

If the valve fails to operate despite meeting all conditions, check the hose line for obstructions or a hose mender restricting normal air flow.

SCV-Series Selection Guide

1. Sketch the position of the tool, fittings, safety check and supply line. Measure the length of hose from the safety check to the tool. There should be no jump sizes in the hose between the safety check and the tool. You will need one safety check valve for each branch line feeding the tool. A safety check in the main supply line is also recommended.
2. Determine the hose size you want to protect. Select the same size safety check as the hose size. For example, a 3/8" hose will require a 3/8" safety check. Do not use a different size safety check. One exception to this rule is for 5/8" hose, use a 1/2" safety check valve.
3. Determine the maximum operating air flow (SCFM) required through the safety check during normal use. For example, the maximum air consumption of the largest tool used on that supply line. Determine the optimum cutoff flow by multiplying the maximum operating air flow by 110%.
4. Add to the length of hose, you measured in step 1, length adders to compensate for system components. Add 0.91 m (3') for each elbow, 0.91 m (3') for each tee, 3.05 m (10') for each globe valve, 0.61 m (2') for each gate valve, 0.91 m (3') for each hose fitting. This calculation will result in the total length for your safety check valve selection. Find the column in the Unobstructed Air Flow Chart, below, that corresponds to your hose size and the row that corresponds to your calculated total length. Where they intersect, is the unobstructed air flow in SCFM.
5. If the optimum cutoff flow is 80% of the unobstructed air flow or less, you should use the optimum cutoff flow (110% of the maximum calculated air flow) to select the appropriate safety check valve. To do this, find the safety check that has a corresponding cutoff flow rate in the product list on the next page.
6. If the optimum cutoff flow is greater than 80% of the unobstructed air flow, there may be a problem with the safety check valve sensing the difference between normal air demand and a line rupture. You may want to consider removing fittings from the flow path, reducing the length of your hose or increasing your hose diameter. If you are not sure, call your Dixon® distributor for assistance.
7. Always install one safety check and test the performance of the system before you continue other installations. When start-up is underway, open the air control valve at the compressor or manifold *very slowly* to allow air to bleed through the check valve so that pressure is equalized on each side of the valve. If the valve fails to operate despite meeting all conditions, check the supply line for obstructions or a hose mender restricting normal air flow.

Unobstructed Air Flow Chart (SCFM)

Total Length (feet)	Hose Size (I.D.)										
	1/4"	3/8"	1/2"	5/8"	3/4"	1"	1-1/4"	1-1/2"	2"	2-1/2"	3"
5	28	66	124	199	294	550	1200	1800	3300	5300	7900
8	27	65	123	196	290	540	1140	1700	3100	5000	7500
10	27	64	121	194	286	531	1100	1640	3000	4600	7200
20	26	62	116	189	278	520	960	1420	2500	4200	6300
30	24	58	108	175	258	480	850	1280	2300	3800	5600
50	22	54	101	163	240	447	720	1080	2000	3200	4700
75	20	47	86	140	207	385	670	960	1850	3000	4400
100	17	41	77	124	178	340	620	940	1760	2800	4200
150	15	35	65	105	158	290	590	870	1630	2600	3900
200	13	30	57	92	136	253	550	820	1520	2400	3600
250	11	27	51	83	123	228	520	780	1450	2300	3400
300	10	25	47	56	114	210	500	750	1390	2200	3300

Length Adders: 3' for each elbow
 3' for each tee
 10' for each globe valve
 2' for each gate valve
 3' for each hose fitting

• Use 1/2" Safety Check Valve for 5/8" hose.

Not recommended for applications requiring 100% of the available air supply. These applications include, but are not limited to, sand blast equipment, pile driving rigs, and expansion joint blow down pipes.

It is recommended to install auxiliary safety devices, including King Cables®, to ensure optimum safety for the operator in the event of a coupling failure or hose rupture. (see page 46)



NPT and Hose I.D. Size	Part #	Cut-off Flow Range (SCFM at 90 PSI)
1/4"	SCVL2	23-29
	SCVM3	39-47
3/8"	SCVS3	52-65
	SCVM4	70-78
1/2"	SCVS4	80-96
	SCVL6	72-88
3/4"	SCVM6	92-108
	SCVR6	112-128
	SCVJ6	132-148
	SCVS6	160-180
	SCVH6	180-200
	SCVL8	165-195
1"	SCVM8	220-260
	SCVS8	280-320
	SCVH8	310-340
	SCVL10	260-290
1-1/4"	SCVM10	300-340
	SCVS10	440-500
	SCVH10	570-630
1-1/2"	SCVL12	300-360
	SCVM12	470-530
	SCVS12	640-720
	SCVH12	750-830
2"	SCVL16	510-590
	SCVM16	725-825
	SCVS16	900-1050
	SCVH16	1100-1200
3"	SCVL24	1200-1400
	SCVS24	2400-2700
	SCVH24	2850-3050

Performance Specifications

- High flow design results in maximum flow with minimal pressure drop
- Automatically and instantly protects the operator against hose whip in the event of a damaged hose or coupling
- In the event of a hose rupture or coupling failure, the valve will automatically reset after the problem is fixed.
- SCV-Series is available in a large selection of sizes ranging from 1/4" to 3", NPTF or BSPP/BSPT threads.
- Valve operation is fully compliant with OSHA Safety Regulation 1926.302(b)(7), (referenced on Page 1).



Performance Specifications	Operating Bar (PSI)	Minimum Burst Bar (PSI)	Temperature °C (°F)	Air Flow ¹ 30.5m (100')
1/4"	350 (24 Bar)	138 (2,000)	121 (250)	17 SCFM
3/8"	350 (24 Bar)	138 (2,000)	121 (250)	41 SCFM
1/2"	350 (24 Bar)	138 (2,000)	121 (250)	77 SCFM
3/4"	350 (24 Bar)	138 (2,000)	121 (250)	178 SCFM
1"	350 (24 Bar)	138 (2,000)	121 (250)	340 SCFM
1-1/4"	350 (24 Bar)	138 (2,000)	121 (250)	620 SCFM
1-1/2"	350 (24 Bar)	138 (2,000)	121 (250)	940 SCFM
2"	350 (24 Bar)	138 (2,000)	121 (250)	1,760 SCFM
2-1/2"	350 (24 Bar)	138 (2,000)	121 (250)	2,800 SCFM
3"	350 (24 Bar)	138 (2,000)	121 (250)	4,200 SCFM

¹ Air flow rating is based upon calculated values using unobstructed air flow for the applicable hose size.

King Cable®

Features

- Must be installed in the extended position (no slack) 
- Cable reaches across hose fittings to provide standby safety for hose
- Spring-loaded loops in the cable ends open easily to pass over the couplings for a firm grip on the hose
- No tools needed - easy to install and remove
- Cables shipped with safety restraint labels attached
- Highly resistant to rust and corrosion
- Hose-to-hose or hose-to-rigid outlet
- Maximum operating pressure: **200 PSI**
- Minimizes damage to equipment and injuries to operators in the event hose, couplings or clamps fail, or there is an accidental separation of the assembly

Materials

- For WB1, WB3, WA2, WA4, WSR1, WSR3, WSR2, WSR4, WSR1C, WB1C, WSR1E:
wire rope: galvanized carbon steel
ferrules: aluminum
springs: galvanized carbon steel
- For WB1SS, WA2SS, WSR1SS, WSR2SS:
wire rope: 304 stainless steel
ferrules: copper
springs: 304 stainless steel
- For WA2B:
wire rope: galvanized carbon steel
ferrules: copper
springs: galvanized carbon steel

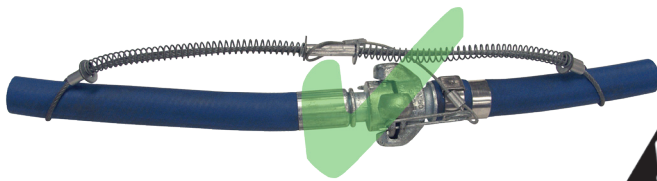

Correct Installation
King Safety Cable installed in the extended position
(no slack)

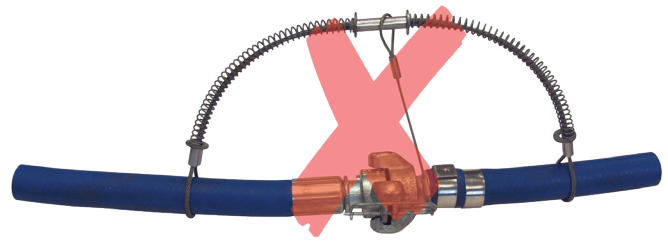

Incorrect Installation
King Safety Cable is not installed in the extended position
(too much slack)

For OSHA regulations please reference osha.gov

King Cable®

Features

- Hose-to-hose or hose-to-tool endmininate injuries caused by broken air hose connections
- Highly resistant to rust and corrosion
- No tools needed - easy to install and remove
- Maximum working pressure **200 PSI**



Style WSR, for hose-to-tool service

Hose I.D.	Cable	Length	Maximum Working Pressure (PSI)	Steel Part #	Stainless Steel Part #
1/2" - 1-1/4"	1/8"	20-1/4"	200	WSR1	WSR1SS
1/2" - 2"	3/16"	28"	200	WSR3	---
1-1/2" - 3"	1/4"	38"	200	WSR2	WSR2SS
4"	3/8"	44"	200	WSR4	---



Style W, for hose-to-hose service

Hose I.D.	Cable	Length	Maximum Working Pressure (PSI)	Steel Part #	Stainless Steel Part #
1/2" - 1-1/4"	1/8"	20-1/4"	200	WB1	WB1SS
1/2" - 2"	3/16"	28"	200	WB3	---
1-1/2" - 3"	1/4"	38"	200	WA2	WA2SS
4"	3/8"	44"	200	WA4	---

Note: Cables are shipped with safety restraint labels attached.

King Cable® Options

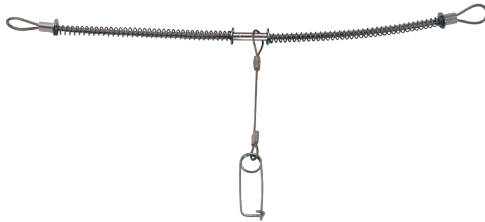

WB1C
WB1 with safety clip and lanyard



WSR1E
WSR1E with stainless steel marine eye

Hose I.D.	Cable	Part #	Description	Maximum Working Pressure (PSI)
1/2" - 1-1/4"	1/8"	WSR1C	WSR1 with safety clip and lanyard used to lock Air King® couplings	200
1/2" - 1-1/4"	1/8"	WB1C	WB1 with safety clip and lanyard used to lock Air King couplings	200
1/2" - 1-1/4"	1/8"	WSR1E	WSR1 with stainless steel safety marine eye used to connect safety cable to a bolt on tool	200
1-1/2" - 3"	1/4"	WA2B	WA2 with bronze/copper ferrule for special environmental conditions	200

NOTE: For King Cable installation procedures please reference dixonvalve.com

Nylon King Cable®

Applications

- Pneumatic, hydraulic and water hoses

Features

- Strong, flexible nylon webbing
- Superior corrosion and spark resistance over metal restraints
- Rubber grommets securely choke eyes around hose
- Must be installed in the extended position (no slack)
- Shipped with labels detailing working pressures and safety instructions
- Maximum working temperature: **200°F (93°C)**
- Minimizes damage to equipment and injuries to operators in the event hose, couplings or clamps fail, or there is an accidental separation of the assembly
- Contact Dixon at 888.226.4673 for additional options

Materials

- Strap: nylon
- Grommets: rubber



Length	Recommended for use on the following hose inside diameters:								Nylon Part #
	1/4"	1/2"	3/4"	1"	2"	3"	4"	6"	
	Hose maximum working pressure (PSI) for above hose I.D.'s								
30"	26,000	6,500	2,900	1,650	400	---	---	-	WBN130
40"	---	---	---	1,650	400	175	100	-	WBN140
30"	52,000	13,000	5,800	3,300	750	---	---	-	WBN230
64"	---	---	---	---	750	350	200	90	WBN264
44"	---	---	---	7,300	1,800	820	450	-	WBN344
64"	---	---	---	---	2,300	1,040	580	260	WBN464

King Safety Whipsocks

Application

- Ideally suited for applications where the media being transferred is under higher working pressures such as air, water, hydraulic and slurry

Materials

- Wire rope: galvanized carbon steel
- Ferrules: aluminum



KSW32



KSW40

Features

- King Safety Whipsocks keep the hose under control in the event of a high-pressure hose assembly failure
- Dual anchor points secured beyond the fittings eliminate hose whip
- Be sure the anchoring points are rated for the application
- Galvanized steel woven stockings extend down the hose to grip securely over a larger area preventing whip, abrasion and wear
- Securing both eye-to-rigid or eye-to-eye anchor points reduce whip in the event of a hose connection failure
- Contact Dixon® with questions regarding working pressure, available options or custom configurations



Size	O.D. Range	Length	Maximum Working Pressure (PSI)	Part #
3/8"	.315" - .5512"	15.75"	5000	KSW06
1/2"	.5512" - .7874"	21.65"	3000	KSW08
3/4"	.7874" - 1.181"	25.20"	2000	KSW12
1"	1.181" - 1.575"	34.25"	1500	KSW16
1-1/4"	1.575" - 1.969"	38.19"	1000	KSW20
1-1/2"	1.969" - 2.362"	49.21"	700	KSW24
2"	2.362" - 2.756"	51.18"	1300	KSW32
2-1/2"	2.756" - 3.346"	53.15"	800	KSW40
3"	3.346" - 3.937"	72.44"	750	KSW48
3-1/2"	3.937" - 4.724"	72.05"	550	KSW56
4"	4.724" - 5.512"	86.61"	550	KSW64
6"	5.512" - 7.087"	93.31"	250	KSW96

King Safety Shackle

Applications

- 2 shackles are used to anchor the King Safety Whipsock
- Securing both eyes to a rigid anchor point to reduce whip in the event of a hose or connection failure

Features

- Recommended bolt, nut, and cotter pin style shackle
- Caution working load must be rated for the application



Size	Working Load	Fits KSW Eye	Micro Alloy Steel Part #
1/4"	1/2 ton (1000 lbs)	KSW06-KSW12	KSS04
3/8"	1-1/2 ton (3000 lbs)	KSW16-KSW40	KSS06
1/2"	3 ton (6000 lbs)	KSW48-KSW96	KSS08

Dixon® In-Line Lubricators

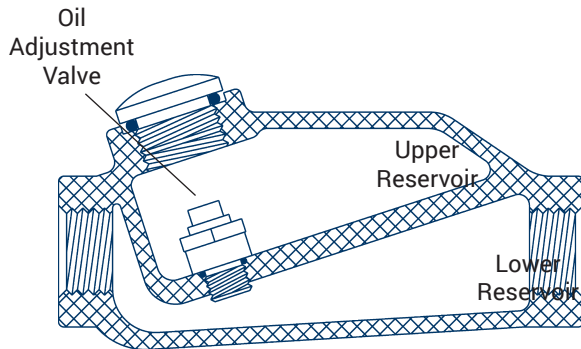

Features

- The minimum flow rate that must be achieved for the PL series lubricators to work is 30 SCFM. A flow rate less than 30 SCFM will not create the pressure difference needed between chambers to force the oil into the air stream.
- Install within 25 feet of the air tool requiring lubrication. Refer to the arrow for proper air flow direction.
- Transparent sight disc allows visual inspection of oil level
- Oil flow regulated by screwdriver adjustment of oil adjustment valve inside body
- Not recommended for constant flow applications
- For use on reciprocating tools only
- Can dispense standard air tool lubricant or Dixon anti-freeze lubricant
- Lubricator body is 356-T6 aluminum

Description

- The lubricator has two reservoirs. The upper reservoir holds the oil, and a lower reservoir that is the passageway for the air to enter. The air and oil mixture exits through the lower reservoir. The oil adjustment valve between the two compartments initially allows air to enter the reservoir to pressurize it, and then it controls the amount of oil entering the air stream.

How it works

- Before the hose is charged with air, the pressure in both chambers of the lubricator are equal. When the tool is turned on it draws air from the compressor through the lower chamber. As air passes through the lower chamber it creates an area of low pressure. When the pressure in the lower chamber is less than the pressure in the upper chamber the dual purpose oil adjustment valve allows oil to flow at the set rate into the airstream of the chamber below to lubricate the tool. When the flow of air stops, the oil adjustment valve allows pressure to build in the top chamber until the pressure is equal between the top and bottom. As long as the pressure in the upper chamber is less than or equal to the pressure in the lower chamber no oil will flow through the oil adjustment valve.

NOTE: These lubricators are only recommended for use with tools that are frequently turned on and off.



Installation

- At start up, additional lubricant is required to coat the inside of the line between the lubricator and the tool. To avoid operating a dry tool, add 1/2 ounce (15cc) of oil directly into the line.
- By removing the fill plug and using a screwdriver, the operator can adjust the amount of oil flowing into the air stream. It is not necessary to shut off the airflow to do this.
- The viscosity of the oil used and uniqueness of the application determine the right setting for proper lubrication. A setting of 5 is suitable for average conditions using 10-weight oil. Remember that the lag time between adjustment and resulting effect at the tool may be as long as an hour. Make small adjustments, and check the result.

Storage

- The simple principle behind the operation of this lubricator does not provide for oil shut off when the tool is not being used. To prevent a pressure differential from forcing the remaining oil from the reservoir into the air line, turn the lubricator upside down or open the fill plug to depressurize the reservoir.

Safety Notes

- Wear eye protection when connecting or disconnecting couplings. Always use a whip hose with impact tools, King Cable® to protect junctions, and couplings that are compatible with the media being transferred.
- Always unscrew fill plug slowly to depressurize upper chamber before filling or adjusting valve.

In-Line Lubricator

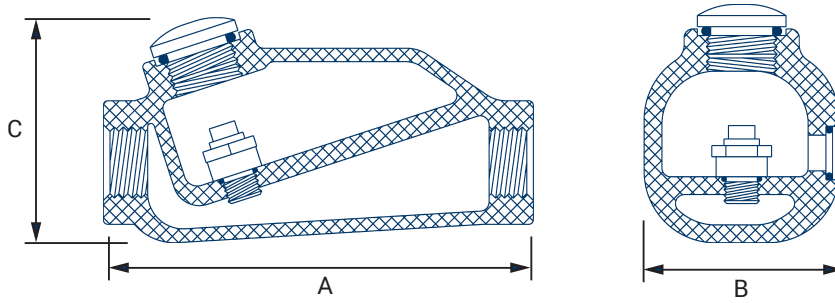

NPT Sizes	Part #	Oil Capacity	Maximum Working Pressure	Air Flow at 70 PSI	Length A	Width B	Height C	Weight
1/2"	PL300	1.4 fluid ozs.	500 PSI	30 SCFM	4-1/2"	2-1/4"	2-1/4"	14 ozs.
3/4"	PL400	3.7 fluid ozs.	200 PSI	70 SCFM	6"	2-3/4"	2-3/4"	22 ozs.
3/4"	PL400L	11.0 fluid ozs.	300 PSI	70 SCFM	7"	3-1/2"	3-3/4"	38 ozs.
1"	PL500	16.0 fluid ozs.	250 PSI	100 SCFM	10"	4-1/4"	4"	69 ozs.

Available with Filter



Feature

- Consists of 9076M particle filter with 40 micron sintered bronze element and PL400 (3.7 ounce) or PL400L (11.0 ounce) lubricator

NPT Size	Oil Capacity	Maximum Working Pressure at ambient Temperature 70°F (21°C)	Aluminum Part #
3/4"	3.7 fluid ozs.	200 PSI	PL400WF
3/4"	11.0 fluid ozs.	300 PSI	PL400LWF

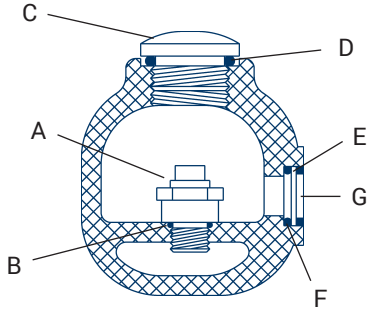

Repair Parts (same for all sizes)

Description	Part #
(A) oil adjustment valve assembly	851661
(B) valve gasket	452531
(C) fill plug	452525
(D) fill plug O-ring	844319
(E) sight disk	452532
(F) sight disk seal	847272
(G) sight disk lock nut	452533

Type of oil to use

- Any petroleum-base, non-detergent light weight oil (SAE 10/150SSU) which will readily break up into a mist, i.e., Mobil DTE light or comparable oil. Do not use any synthetic oil or oils containing additives or solvents.



Lubricant

Part #	Size
DATL016	1 pint
DATL128	1 gallon

Anti-Freeze

Part #	Size
DATL016W	1 pint
DATL128W	1 gallon

Air Accessories



Safety Pop-Off Valves

Filters, Regulators and Lubricators

Gauges

Ball Valves

Boss® Fittings and Clamps

3500-Series nipples

Bent Stem Swivels

Compressor Y fitting

Please reference the current Dixon® Product List catalog or dixonvalve.com for air accessories

Gauges



Features

- Designed for long reliable service
- Standard dry and liquid-filled pressure gauges, compound pressure gauges, vacuum gauges, and welding gauges

Materials

- Materials available in brass, stainless steel, plastic

3500 Nipples

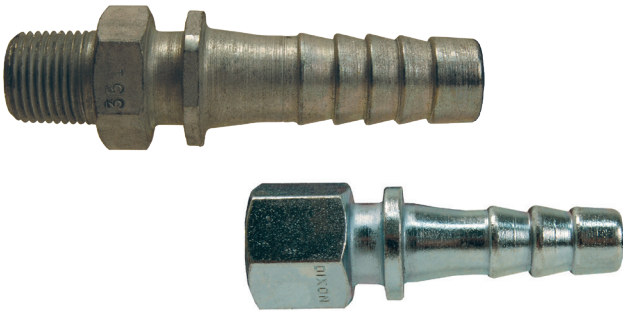

Feature

- Used with whip hose to withstand vibration

Material

- Zinc-plated steel

Specifications

- Male nipple: hose size 1/4" - 1", NPT size 1/8" - 1"
female nipple: hose size 1/4" - 3/4", NPT size 1/4" - 3/4"

Compressor Y



Feature

- Converts a single supply source to a dual outlet

Material

- Material: iron

Specifications

- Female NPT 1" (1), male NPT 3/4" (2)

Safety Pop-Off Valves



Features

- National Board Certified Safety Valves
- Available in heavy duty high capacity, standard, and soft seat

Materials

- Material brass and stainless steel

Specification

- Maximum operating temperature 400°F (204°C)

Safety Vented Ball Valves

Features

- Handle position quickly indicates if valve is open or closed
- Blow-out proof stem design
- RTFE seats and stuffing box ring

Specification

- Rated to **600 PSI**



Steel Bent Stem Swivels

Features

- Convenient air tool connectors
- Comes in 7/8" thread which fits most chipping hammers

Specification

- Designed for normal operation at **90 PSI** at ambient temperature **70°F (21°C)**

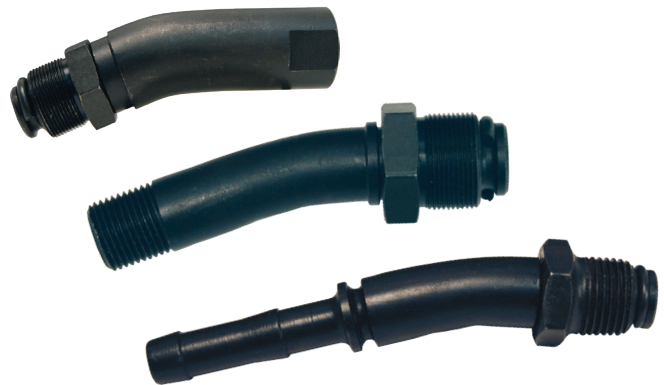

Hose Rack and Reels

Features

- Reelcraft spring driven hose reels
5000, 7000, and 80000 series available
- Hose racks for hose sizes 1-1/2" to 2-1/2", 50' to 200'



Filters, Regulators and Lubricators



Features

- Series 1, Watts, and Wilkerson brands available
- Inventories all components and sizes from 1/8" to 2"
- General purpose, rugged and reliable

Safety Tag and Tape



Features

- Tags sold in quantities of 100
- Length of tape - 55 yards, approximately 255 warnings



Air Supply Requirements (Operating Pressure: 90 PSI)

Tool	Class	Typical Air Consumption (CFM)	Hose Size (inches)		
			0-10 ft.	10-50 ft.	50-200 ft.
Paving Breakers	25 lb.	45	1/2"	1/2"	3/4"
	35 lb.	50	1/2"	3/4"	3/4"
	60 lb.	65	1/2"	3/4"	1"
	80 lb.	80	3/4"	3/4"	1"
Claydiggers		45	1/2"	1/2"	3/4"
Hand Drills	8 lb.	20	3/8"	3/8"	1/2"
	15 lb.	32	3/4"	1/2"	1/2"
Rock (Sinker) Drills	45 lb.	105	3/4"	3/4"	1"
	55 lb.	130	3/4"	1"	1"
Tampers	5" butt	20	3/8"	1/2"	1/2"
	6" butt	30	1/2"	1/2"	3/4"
Sump Pump Sludge Pump	3 HP	100	3/4"	3/4"	1"
	Ejector	90	1"	1"	1"
Vibrators	2-1/2"	60	1"	1"	1"
	3"	60	1"	1"	1"
Chipping Hammers		25	3/8"	1/2"	1/2"
Impact Wrenches	3/8" sq. dr.	10	5/16"	3/8"	3/8"
	1/2"	15	5/16"	3/8"	1/2"
	3/4"	25	3/8"	1/2"	1/2"
	1"	50	1/2"	3/4"	3/4"
Drills	1/4" - 1/2"	22	3/8"	3/8"	1/2"
Grinders	die/burr	20	3/8"	3/8"	1/2"
	small angle	20	3/8"	3/8"	1/2"
	3 HP vertical	75	1/2"	3/4"	1"

Pressure Conversions

100 PSI = 6.9 Bars

250 PSI = 17.25 Bars

600 PSI = 41.4 Bars

5 Bars = **72.5 PSI**

10 Bars = **145 PSI**

25 Bars = **362.5 PSI**

Force Chart

Force (In Pounds)

Hose I.D.	25 PSI	50 PSI	75 PSI	100 PSI	150 PSI	200 PSI	250 PSI	300 PSI	500 PSI	1000 PSI
1/4"	1	2	4	5	7	10	12	15	25	49
3/8"	3	6	8	11	17	22	28	33	55	110
1/2"	5	10	15	20	29	39	49	59	98	196
3/4"	11	22	33	44	66	88	110	133	221	442
1"	20	39	59	79	118	157	196	236	393	785
1-1/4"	31	61	92	123	184	245	307	368	614	1227
1-1/2"	44	88	133	177	265	353	442	530	884	1767
2"	79	157	236	314	471	628	785	942	1571	3142
2-1/2"	123	245	368	491	736	982	1227	1473	2454	4909
3"	177	353	530	707	1060	1414	1767	2121	3534	7069
4"	314	628	942	1257	1885	2513	3142	3770	6283	12566
5"	491	982	1473	1964	2945	3927	4909	5891	9818	19635
6"	707	1414	2121	2827	4241	5655	7069	8482	14137	28274
8"	1257	2513	3770	5027	7540	10053	12566	15080	25133	50266
10"	1964	3927	5891	7854	11781	15708	19635	23562	39270	78540
12"	2827	5655	8482	11310	16965	22620	28274	33929	56549	113098

NOTE: For hose I.D.'s from 1-1/4" to 12" the force in pounds is greater than the PSI.

- Force is the dynamic power which is exported longitudinally through a hose, towards the ends. To arrive at the number of pounds of force exerted, you merely multiply the area of the I.D. times the working pressure being used.
- Area of a circle: $\pi \times r^2$ (PI [3.1416] times radius squared)
- Force = Area x Pressure

Limited Warranty

DIXON VALVE AND COUPLING COMPANY, LLC (herein called "Dixon") warrants the products described herein and manufactured by Dixon to be free from defects in material and workmanship for a period of one (1) year from date of shipment by Dixon under normal use and service. Its sole obligation under this warranty being limited to repairing or replacing, as hereinafter provided, at its option any product found to Dixon's satisfaction to be defective upon examination by it, provided that such product shall be returned for inspection to Dixon's factory within three (3) months after discovery of the defect. The repair or replacement of defective products will be made without charge for parts or labor. This warranty shall not apply to: (a) parts or products not manufactured by Dixon, the warranty of such items being limited to the actual warranty extended to Dixon by its supplier; (b) any product that has been subject to abuse, negligence, accident, or misapplication; (c) any product altered or repaired by others than Dixon; and (d) to normal maintenance services and the replacement of service items (such as washers, gaskets, and lubricants) made in connection with such services. To the extent permitted by law, this limited warranty shall extend only to the buyer and any other person reasonably expected to use or consume the goods who is injured in person by any breach of the warranty. No action may be brought against Dixon for an alleged breach of warranty unless such action is instituted within one (1) year from the date the cause of action accrues. This limited warranty shall be construed and enforced to the fullest extent allowable by applicable law.

Other than the obligation of Dixon set forth herein, Dixon disclaims all warranties, express or implied, including but not limited to any implied warranties of merchantability or fitness for a particular purpose, and any other obligation or liability. The foregoing constitutes Dixon's sole obligation with respect to damages, whether direct, incidental, or consequential, resulting from the use or performance of the product.

Some products and sizes may be discontinued when stock is depleted or may require a minimum quantity for ordering.

About This Catalog and Our Products

This catalog is intended as a product offering. It is not a user or technical manual. Information in this catalog is subject to change without notice. We may modify product design and specification without notice and without any obligation to modify or substitute products previously purchased. All users and distributors of products sold through this catalog are strongly encouraged to contact Dixon with questions on use, compatibilities, coupling procedures, and life of product. Our full-time engineering and test staff are always available to recommend uses and to assist distributors and users with questions.



Safety



Safety logos, which appear throughout our catalog, are used as a reminder that the user should carefully review for the appropriateness of the product for the media, application, and environment in which it will be used.

NOTE: Because of the health hazards associated with contamination and lead content in drinking water systems, Dixon couplings, unless otherwise specifically approved, are not recommended for potable water service and should not be used in applications where drinking water will contact the wetted surfaces of the coupling.

All Dixon products are shipped in cartons with the following warning:

"WARNING: This product contains lead, a chemical known to the State of California to cause cancer and birth defects or other reproductive harm."

Trademarks

Delrin[®] and Zytel[®] are registered trademarks of DuPont Nemours and Company.

Kalrez[®] is a registered trademark of DuPont Dow Elastomers.

All other trademarks appearing in the Dixon illustrated price list are the property of their respective owners.

Copyright

Copyright © 2024 by Dixon Valve and Coupling, LLC

All rights reserved. This book is copyrighted material. Use, reproduction or copying of it by anyone other than Dixon[®] is strictly forbidden without its express written consent.

NOTE: Reasonable care has been taken in preparing this catalog. Dixon Valve & Coupling Company, LLC reserves the right to make corrections.

